

Ignition Switch Assembly

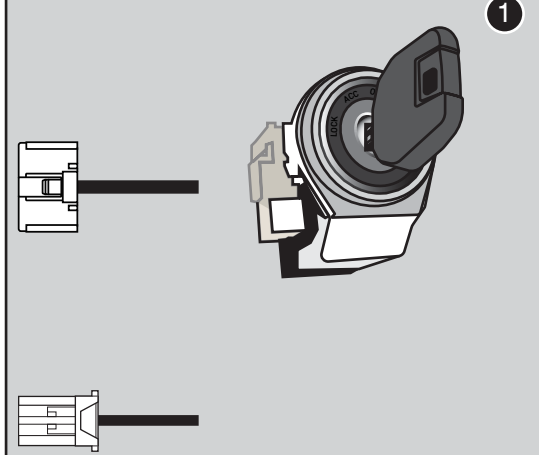

BCM/Fuse Box

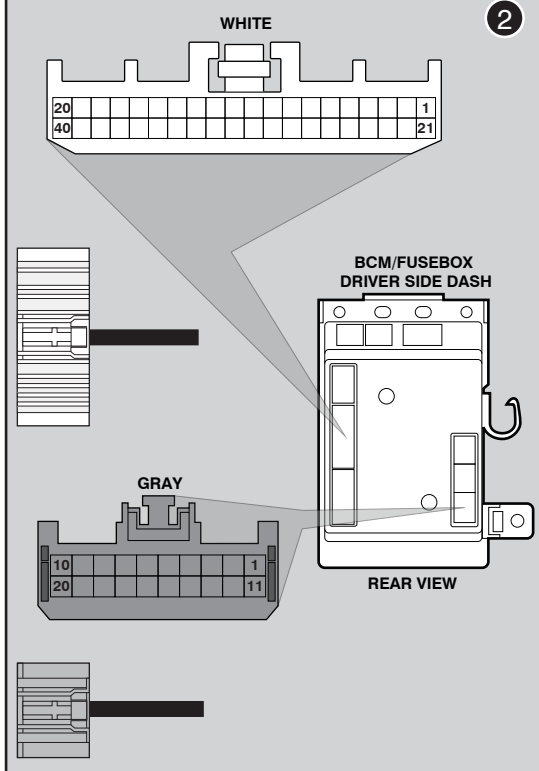

LED Programming Error Codes

- Module LED flashing RED during programming
- 1x RED = Unable to communicate with RFID or immobilizer data.
 - 2x RED = No CAN activity. Check the CAN wire connections.
 - 3x RED = No ignition detected. Check the ignition wire connection and CAN.
 - 4x RED = Required ignition output diode not detected.

CARTRIDGE INSTALLATION

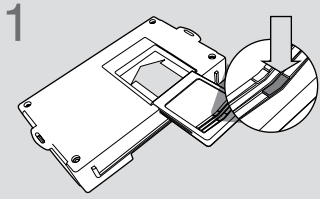

1 Slide cartridge into unit. Notice button under LED.

2

Ready for Module Programming Procedure.

MODULE PROGRAMMING PROCEDURE



1 For this installation, the Weblink HUB is required.



2 Remove OEM key 1 from keychain.



Place all other keyfobs at least 1 foot away from the Weblink HUB. Failure to comply may result in damage to other keyfobs or interfere with the keyfob reading process.



3 Flash the module using the Weblink HUB. Follow the on screen instructions to complete the keyfob reading process.

4

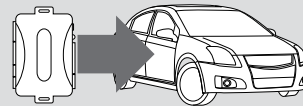

WARNING:
Do not press the module programming button.
Connect power first.
Connect module to vehicle.

5

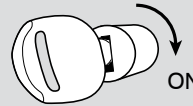

Using OEM key 1, turn key to ON position.

6

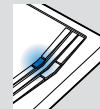

Wait, LED will turn solid BLUE for 2 seconds .

7

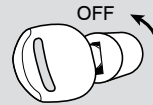

Turn key to OFF position.

8

Module Programming Procedure completed.