

Steering Lock Connector

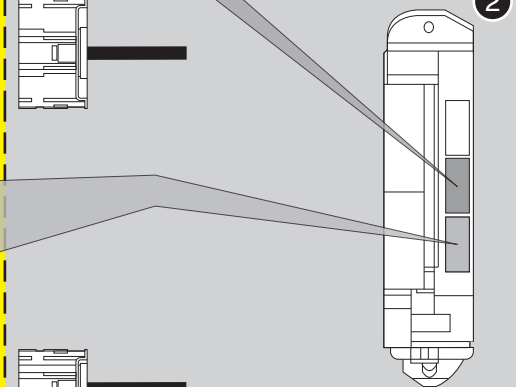

Main Body ECU



**Códigos de error de programación de LED**

El LED del módulo parpadea en ROJO durante la programación

- 1x - Error de CAN, confirmar la configuración del arnés
- 2x - Sin IGN, confirme la configuración del arnés y la alimentación del IGN
- 3x - Error de IMMO / CAN, confirme la configuración del arnés
- 4x - No se VIN, el módulo puede defecto plataforma # 2
- 5x - Desconocido VIN, módulo puede defecto plataforma # 2
- 6x - Arrancador OEM detectado, ciclo IGN, si el problema persiste, eliminar y reprogramar

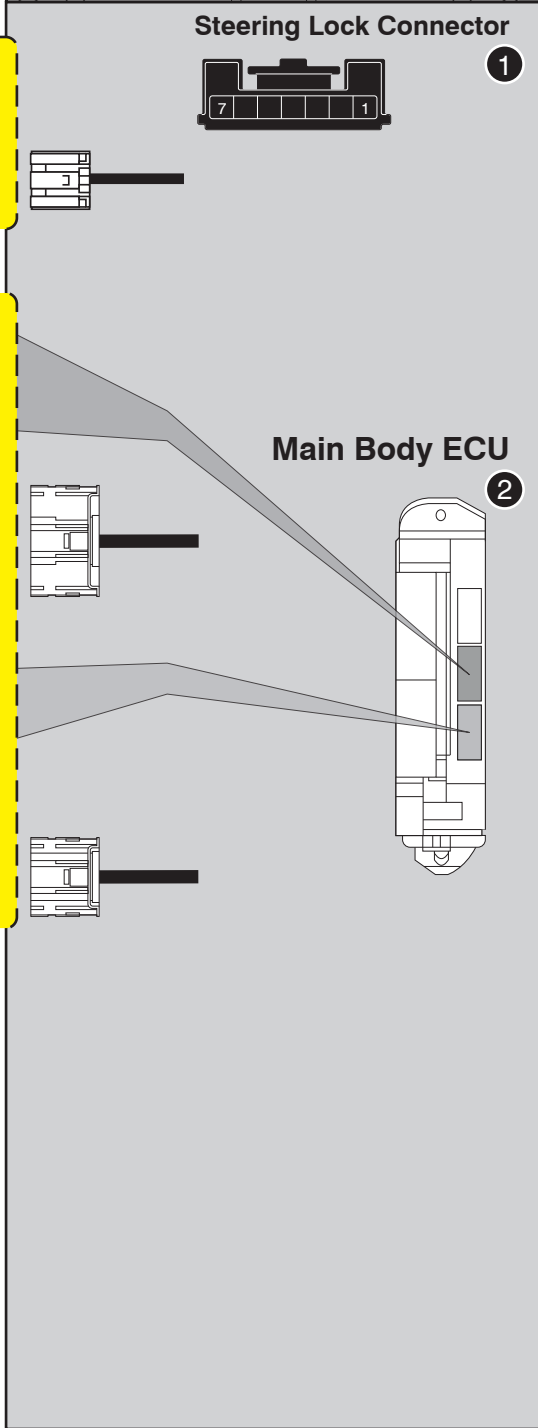
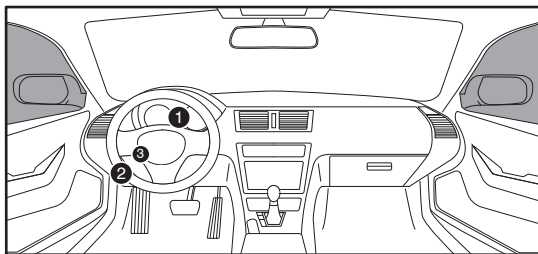
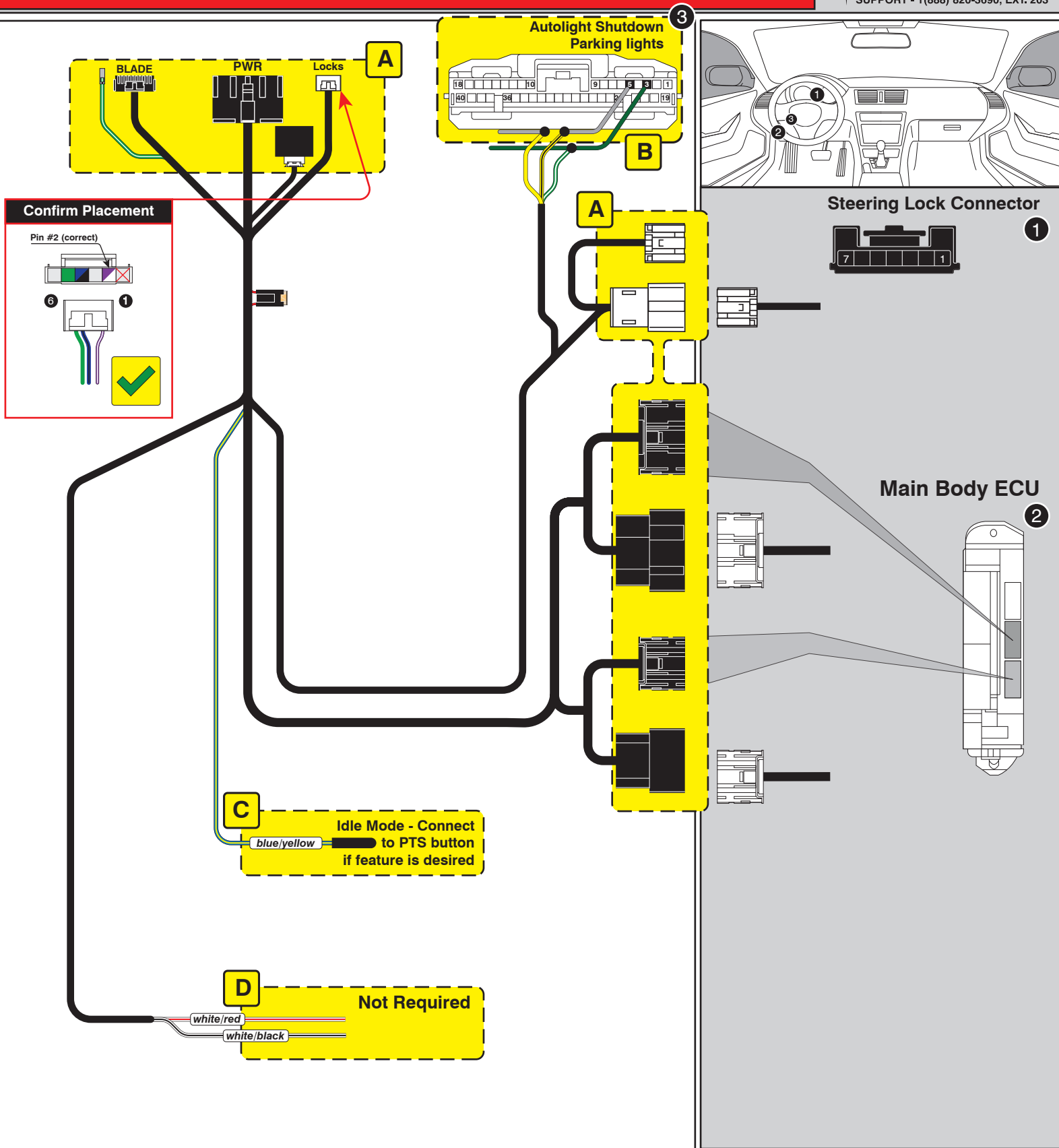

**Códigos de error de programación de LED**  
El LED del módulo parpadea en ROJO durante la programación

- 1x - Error de CAN, confirmar la configuración del arnés
- 2x - Sin IGN, confirme la configuración del arnés y la alimentación del IGN
- 3x - Error de IMMO / CAN, confirme la configuración del arnés
- 4x - No se VIN, el módulo puede defecto plataforma # 2
- 5x - Desconocido VIN, módulo puede defecto plataforma # 2
- 6x - Arrancador OEM detectado, ciclo IGN, si el problema persiste, eliminar y reprogramar

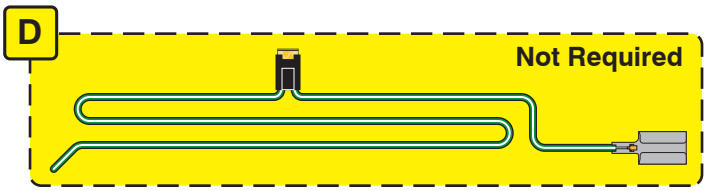

## CARTRIDGE INSTALLATION

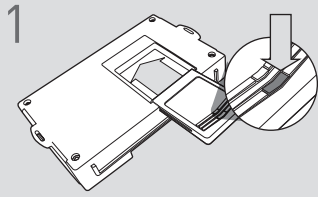

1 Slide cartridge into unit. Notice button under LED.

2

Ready for Module Programming Procedure.

## MODULE PROGRAMMING PROCEDURE

### NOTE

I IMPORTANT: The hood must be closed.



1 Push start button twice [2x] to ON position.

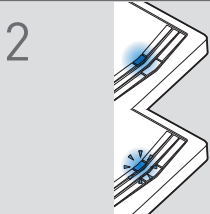

2 Wait, if LED turns solid BLUE for 2 seconds, proceed to step 7.

If LED flashes BLUE rapidly, proceed to step 3.



3 Push start button once [1x] to OFF position.

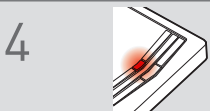

4 Wait, LED will turn solid RED. (This may take up to 5 minutes.)

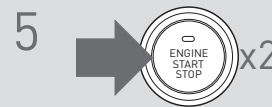

5 Push start button twice [2x] to ON position.

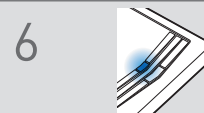

6 Wait, LED will turn solid BLUE for 2 seconds.

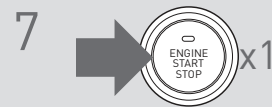

7 Push start button once [1x] to OFF position.

8

Module Programming Procedure completed.