

Overview: The initial production release of the FTI-TLK1 harness has an issue where in some vehicles the secondary power input to the CN1 connector will overload the associated vehicle circuit, causing a fuse to blow. This issue affects the initial release of harnesses and is already being addressed in production. A field correction procedure is detailed below in Figure 1.

Issue: The secondary power circuit can overload some vehicle ignition switch circuits, causing a blown 5A/7.5A AM1 fuse, potentially disabling the vehicle and leaving the consumer stranded. Affected adapters are illustrated below in figure 2.

Corrective steps:

- 1.) Select the applicable CN1 adapter, isolate the RED/WHITE power wire, cut wire approximately 4" from the BLACK plug
- 2.) Insulate the wire still connected to the WHITE plug using heat shrink tubing, and strip the insulation on the other wire end
- 3.) Strip a portion of the insulation from the RED wire, attach the stripped RED/WHITE to the exposed RED wire, solder together
- 4.) Apply insulating tape to the soldered connection and secure the cut ends back to the bundle of wires created by the adapter
- 5.) Correction complete, you may safely proceed to finish your installation

Figure 1: Step by step adapter correction

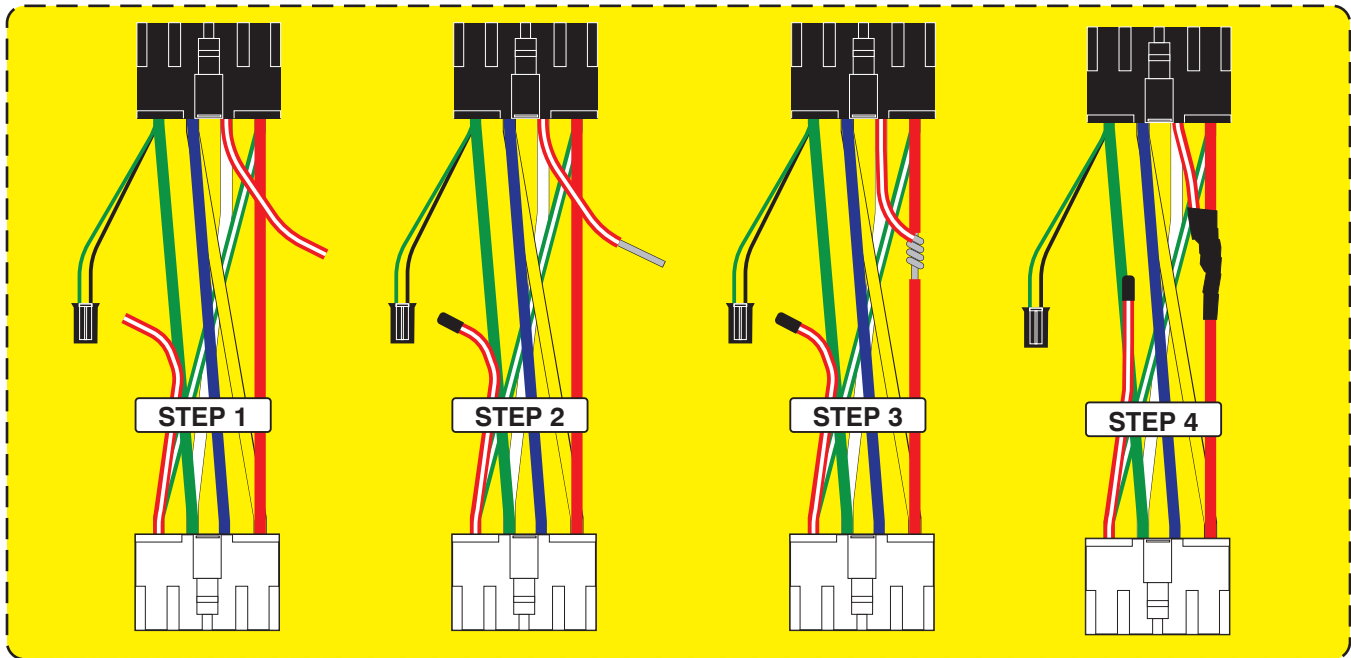
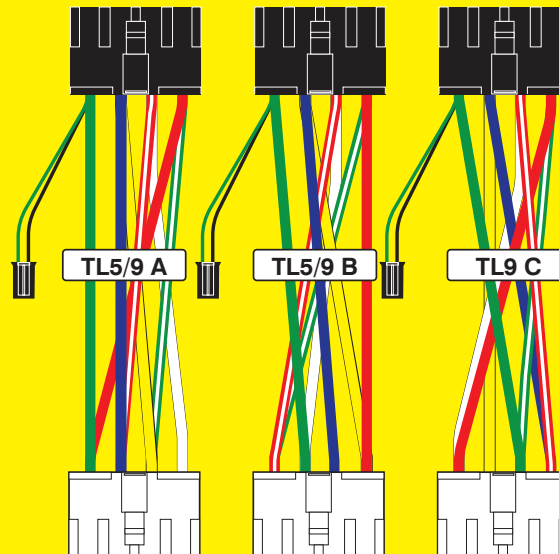

Figure 2: Supplied CN1 Harness Adapters

Incorrect power provisions with the potential to overload vehicle ignition supply circuit, resulting in blown AM1 fuse.



FTI-TLK1 Type 3B5 - Vehicle Coverage & Preparation Notes

RSTECH, L.L.C.
SUPPORT - 1 (888) 820-3690, EXT. 203

Make	Model	Year	Install	CAN	Lights	TPMS	Trunk	I/O Changes
DL-TL9					Park / Auto			Green White/Blue
Toyota	Tundra 80 bit H Key	2020	Type 3/B	BCM	A / B	DKP/35		START 2/None

Hey! Read this stuff before you start the installation...

Firmware: Covered vehicles use **BLADE-AL(DL)-TL9**, flash module and update the controller firmware before installing.

Install: Type 3B vehicles use the **TL 5/9 B CN1 adapter**, *using any other adapters will result in malfunction and damage.*

CAN: Covered vehicles require the CAN source connection to the BCM source connector, the OBD source is not used.

Lights: Type A parking lights require a connection between the **green/white** wires in the **park/auto** and **BECU** harnesses. Type B auto lights require cutting the black **AUTO LT. B** loop on the BECU harness, connecting the loop ends to the **white/red & white/black** wires in the park/auto harness.

Locks: Lock control requires a connection between the harness **RDA** and **RDA 2** wires, secure the unused **RDA 1 & RDA 3** connections for safety.

TPMS: OEM RS control (3X Lock Start) feature requires interrupting the listed TPMS ignition circuits located in the driver kick panel 36-pin connector, in the Tundra the wire is **red**, pin #35, in the white connector. Connect as illustrated.

I/O Changes:

CM900S/900AS: START2: Set feature option 1-6-2 (starter output 10A max) If issues arise disarming the OEM alarm during remote start, set option 1-01 to 2.

CM7000/7200: START2: Move CM jumper 3 to Starter position.

If issues arise disarming the OEM alarm during remote start, set option 1-01 to 2.

Okay, now get to work...

•FT-DAS Required for manual transmission.
•BOTH Red & Red/White MUST be connected with high current application.

Jumper Setting

Parking Light	<input type="checkbox"/>	<input type="checkbox"/>	<input type="checkbox"/>	<input type="checkbox"/>	(+)Door Trigger In
Accessory	<input type="checkbox"/>	<input type="checkbox"/>	<input type="checkbox"/>	<input type="checkbox"/>	(-)Door Trigger In (Default)
Ignition (Default)	<input type="checkbox"/>	<input type="checkbox"/>	<input type="checkbox"/>	<input type="checkbox"/>	
Trunk	<input type="checkbox"/>	<input type="checkbox"/>	<input type="checkbox"/>	<input type="checkbox"/>	Starter
Starter	<input type="checkbox"/>	<input type="checkbox"/>	<input type="checkbox"/>	<input type="checkbox"/>	Ignition
Parking Light (Default)	<input type="checkbox"/>	<input type="checkbox"/>	<input type="checkbox"/>	<input type="checkbox"/>	Accessory (Default)

CM7000/7200 Cut loop for A/T

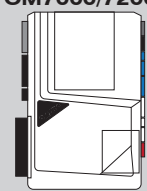
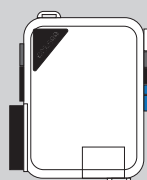
CM-900S/900AS

CM900AS/900S Jumper



**START
ACC
IGN1**



FTI-TLK1 Type 3B5 - Installation Notes & Wiring Diagram

- A** Use TL 5/9 B CN1 adapter, any other adapter will result in malfunction and damage. Jumper connected to IMMO for equipped vehicles, if not equipped, connect to NO IMMO before programming. IGN/GND connection required.
- B** Type 3B3 installs require CAN jumper to be connected to the BCM source connector. Secure unused OBD connector for safety. The harness 30-pin connector is also not used in this install, make no connections with that connector.
- C** Door lock control for this install requires connecting provided **RDA** wire to **RDA 2** connection, secure the unused **RDA 1 & RDA 3** connections for safety.
- D** Type A parking lights, connect harness **green/white** (park/auto harness) to the **green/white** (BECU harness), if equipped with auto-lights, cut **AUTO LT. B** loop and connect as illustrated.
- E** 3X lock start requires interrupting the TPMS ignition. Tundra the wire is **red wire** pin #35 of the 36-pin connector (DKP), Connect as illustrated.

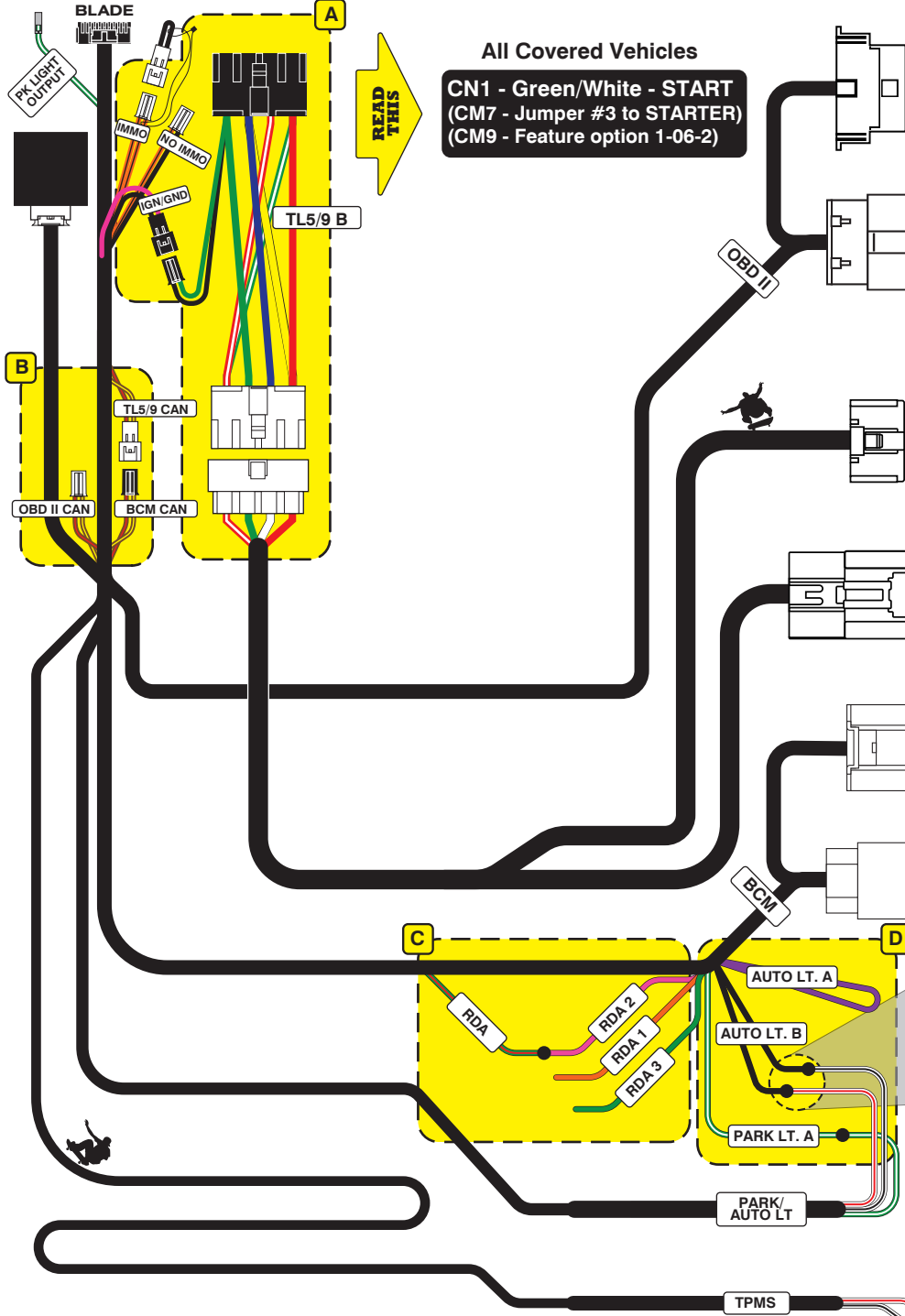

All Covered Vehicles
CN1 - Green/White - START
 (CM7 - Jumper #3 to STARTER)
 (CM9 - Feature option 1-06-2)

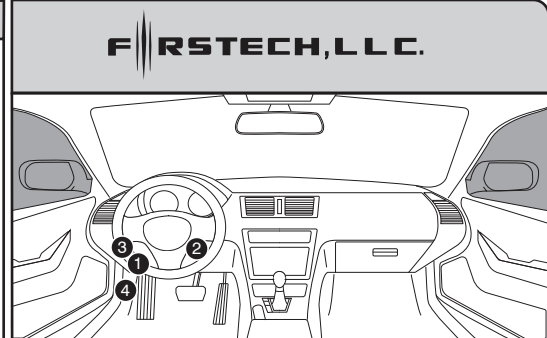

FIRSTECH, L.L.C.

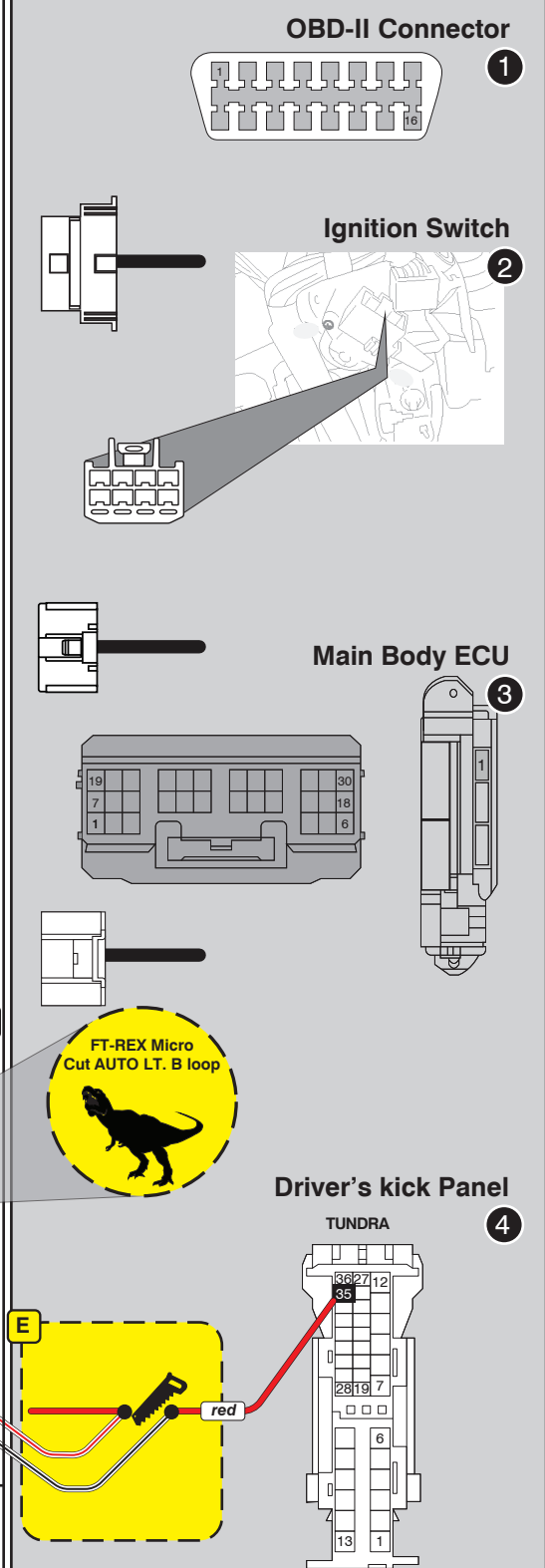

Module Programming Procedure

- Step 1 - Insert key into cylinder (Black key only, not gray)
- Step 2 - Activate ignition, LED will go solid red
- Step 3 - Wait for LED to go solid blue
- Step 4 - Deactivate ignition
- Step 5 - Programming complete

LED Programming Error Codes

- Module LED flashing RED during programming
- 1x - Can error, confirm connections
 - 2x - No IGN, check connections & adapter
 - 3x - No IMMO, confirm connections and equipment level
 - 4x - VIN error, contact engineering

FTI-TLK1 Type 3B5

SUPPORT - 1(888) 820-3690, EXT. 203