

Make	Model	Year	Install	BCM	Lights	Locks	POC 1	I/O Changes
DL-NI4 Nissan	Juke STD Key AT	2011-18	Type 1	LSC	Park / Auto NI-LOCK	DATA	Hazard1/2	Green White/Blue

Installation **Type 1** requires **BLADE-AL(DL)-NI4**, flash module and update the controller firmware before beginning the installation.

I/O Changes: Each vehicle in this installation group have different configuration requirements for proper handling of ACC and START circuit handling. Please ensure that the appropriate changes have been made before testing.

The required, controller specific, changes are listed below.

CM900S/900AS I/O Changes:

Optional Hazard Light Control:

NI-LOCK harness **green/white** is pre-wired for hazards, connect harness wire to the controller POC1 (**green/white**), additional configuration required. Vehicles equipped with a **MOMENTARY** activation switch require that POC1 be configured for **Hazard light** (POC option #30), if the switch is **LATCHING** type you will use **Hazard light 2** (POC option #23).

Auto-Light OFF:

NI-LOCK harness **orange** is pre-wired for Auto-light shut off, if the vehicle is equipped with auto-lights connect CM REARM output (**orange**) to **orange** wire in harness.

D **NI-LOCK harness configuration:** Configure Double Pulse Unlock (**feature 1-04, option 2**) Vehicle lock functions are handled through data, additional harness configuration is not required.

FTI-NSK1: Installation and Configuration Notes

- A** CUTS REQUIRED - INSULATE AFTER CUTTING
- B** REQUIRED CONNECTION - USE JUMPER IF NO IMMOBILIZER
- C** CONNECT AS ILLUSTRATED
- D** CONNECT AS ILLUSTRATED
- E** CONNECT AS ILLUSTRATED



FEATURE COVERAGE																	
IMMOBILIZER DATA	PRIORITY UNLOCK	DOOR LOCK	DOOR UNLOCK	ARM OEM ALARM	DISARM OEM ALARM	TRUNK/HATCH RELEASE	A/M ALARM CTRL	A/M RS CONTROL	HOOD STATUS	DOOR STATUS	TRUNK STATUS	BRAKE STATUS	E-BRAKE STATUS	TACH OUTPUT	SECURE TAKEOVER	PARKING LIGHTS	HAZARD LIGHTS
○	○	○	○							○	○	○	○	○			○

•FT-DAS Required for manual transmission.
•BOTH Red & Red/White MUST be connected with high current application.

Jumper Setting

CM7000/7200 Cut loop for A/T

CM-900S/900AS

CM900AS/900S Jumper

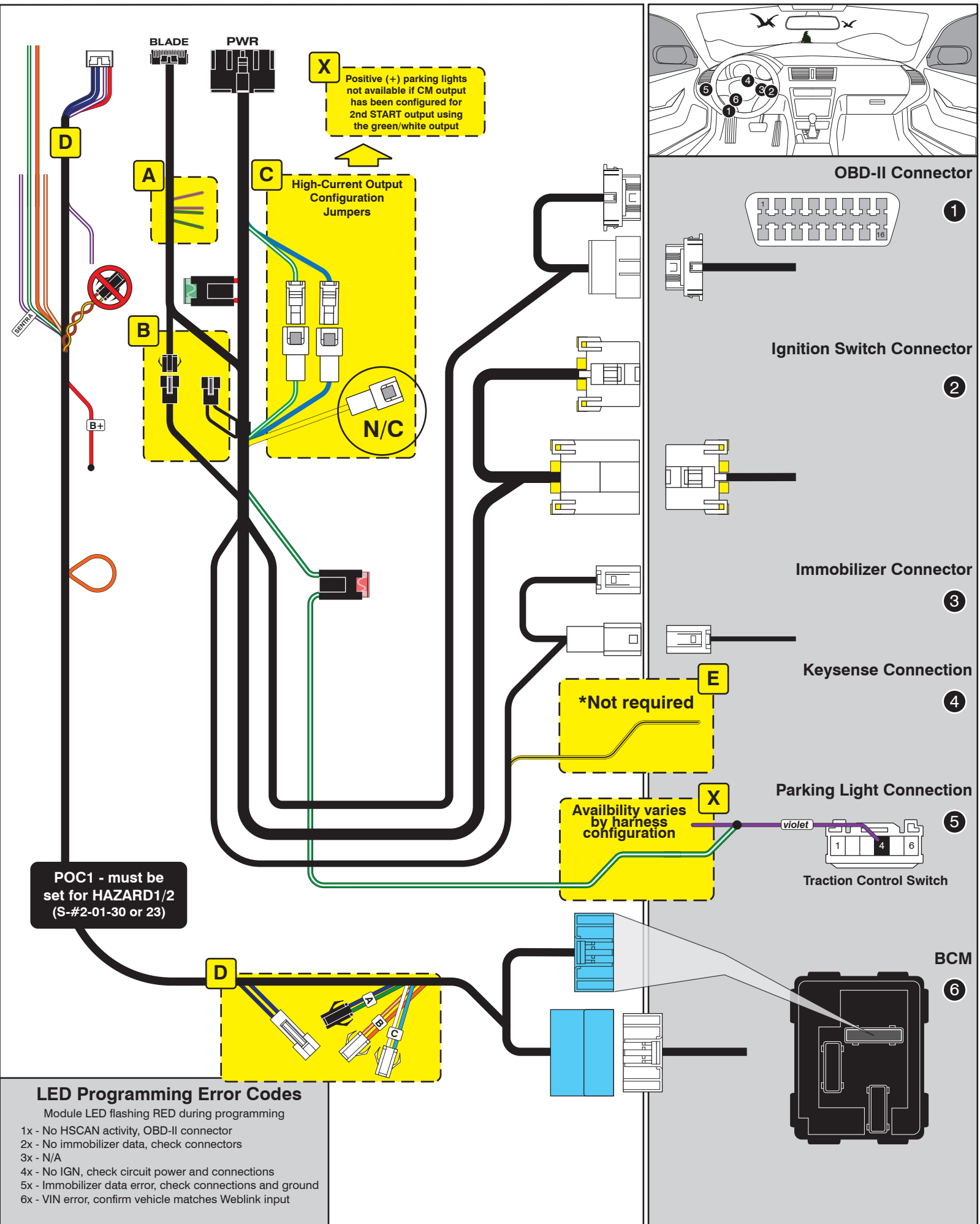

X Positive (+) parking lights not available if CM output has been configured for 2nd START output using the green/white output

C High-Current Output Configuration Jumpers

N/C

E *Not required

X Availability varies by harness configuration

POC1 - must be set for HAZARD1/2 (S-#2-01-30 or 23)

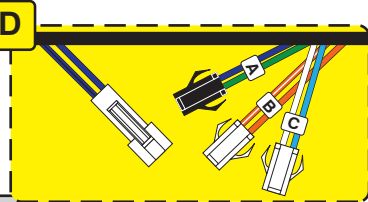

LED Programming Error Codes
Module LED flashing RED during programming

- 1x - No HSCAN activity, OBD-II connector
- 2x - No immobilizer data, check connectors
- 3x - N/A
- 4x - No IGN, check circuit power and connections
- 5x - Immobilizer data error, check connections and ground
- 6x - VIN error, confirm vehicle matches Weblink input

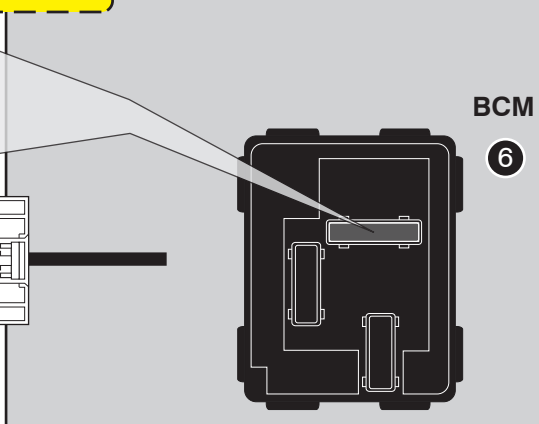
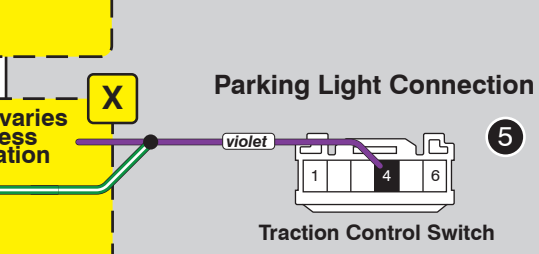
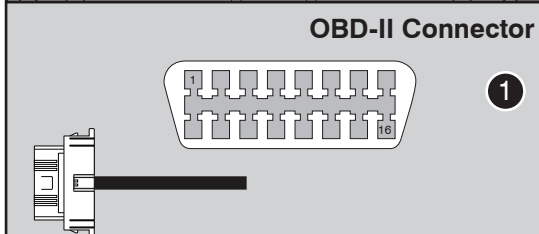
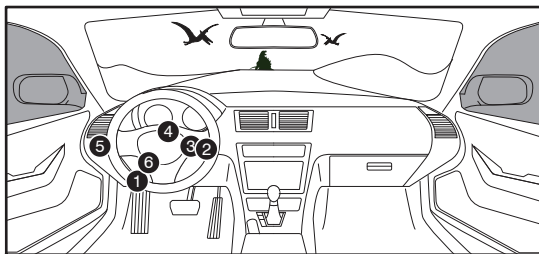

CARTRIDGE INSTALLATION



1 Slide cartridge into unit. Notice button under LED.

2

Ready for Module Programming Procedure.

MODULE PROGRAMMING PROCEDURE

NOTE

I To complete this procedure, use one regular key or one valet key.



II When programming, all key fobs must be located at least 10 feet away from the vehicle.



1 Insert key into ignition.

2

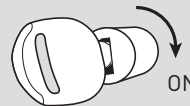

Turn key to ON position.

3

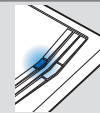

Wait, LED will turn solid BLUE for 2 seconds.

4

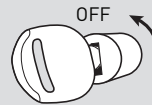

Turn key to OFF position.

5

Module Programming Procedure completed.