

Make	Model	Year	Install	BCM	Lights	Locks	POC 1	I/O Changes
DL-NI4 Nissan	Sentra STD Key AT	2007-13	Type 1	BIC/BGB 2 possible	Park / Auto NI-LOCK	DATA	Hazard1/2	Green White/Blue

Installation **Type 1** requires **BLADE-AL(DL)-NI4**, flash module and update the controller firmware before beginning the installation.

**I/O Changes:** Each vehicle in this installation group have different configuration requirements for proper handling of ACC and START circuit handling. Please ensure that the appropriate changes have been made before testing.

**The required, controller specific, changes are listed below.**

**CM7000/7200 I/O Changes:**

**Optional Hazard Light Control:**

**NI-LOCK** harness **green/white** is pre-wired for hazards, connect harness wire to the controller POC1 (**blue/white**), additional configuration required. Vehicles equipped with a **MOMENTARY** activation switch require that POC1 be configured for **Hazard light** (POC option #30), if the switch is **LATCHING** type you will use **Hazard light 2** (POC option #23).

**Auto-Light OFF:**

**NI-LOCK** harness **orange** is pre-wired for Auto-light shut off, if the vehicle is equipped with auto-lights connect CM REARM output (**orange**) to **orange** wire in harness.

**D** **NI-LOCK harness configuration:** Configure Double Pulse Unlock (**feature 1-04, option 2**) Vehicle lock functions are handled through data, additional harness configuration is not required.

**FTI-NSK1: Installation and Configuration Notes**

- A** CUTS REQUIRED - INSULATE AFTER CUTTING
- B** REQUIRED CONNECTION - USE JUMPER IF NO IMMOBILIZER
- C** CONNECT AS ILLUSTRATED
- D** CONNECT AS ILLUSTRATED
- E** CONNECT AS ILLUSTRATED



**FT-DAS Required for manual transmission.**  
**BOTH Red & Red/White MUST be connected with high current application.**

**Jumper Setting**

Parking Light	Accessory	Ignition (Default)	(+)Door Trigger In	(-)Door Trigger In (Default)
Trunk	Starter	Parking Light (Default)	Starter	Ignition
			Accessory (Default)	

**CM7000/7200** Cut loop for A/T

**CM-900S/900AS**

**CM900AS/900S Jumper**



FEATURE COVERAGE																	
IMMOBILIZER DATA	PRIORITY UNLOCK	DOOR LOCK	DOOR UNLOCK	ARM OEM ALARM	DISARM OEM ALARM	TRUNK/HATCH RELEASE	A/M ALARM CTRL	A/M RS CONTROL	HOOD STATUS	DOOR STATUS	TRUNK STATUS	BRAKE STATUS	E-BRAKE STATUS	TACH OUTPUT	SECURE TAKEOVER	PARKING LIGHTS	HAZARD LIGHTS

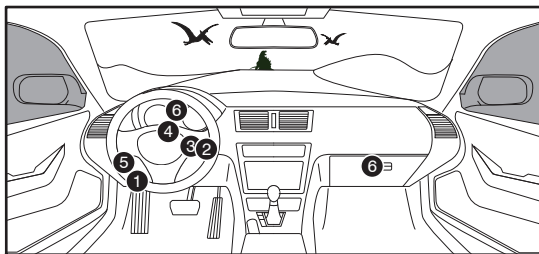
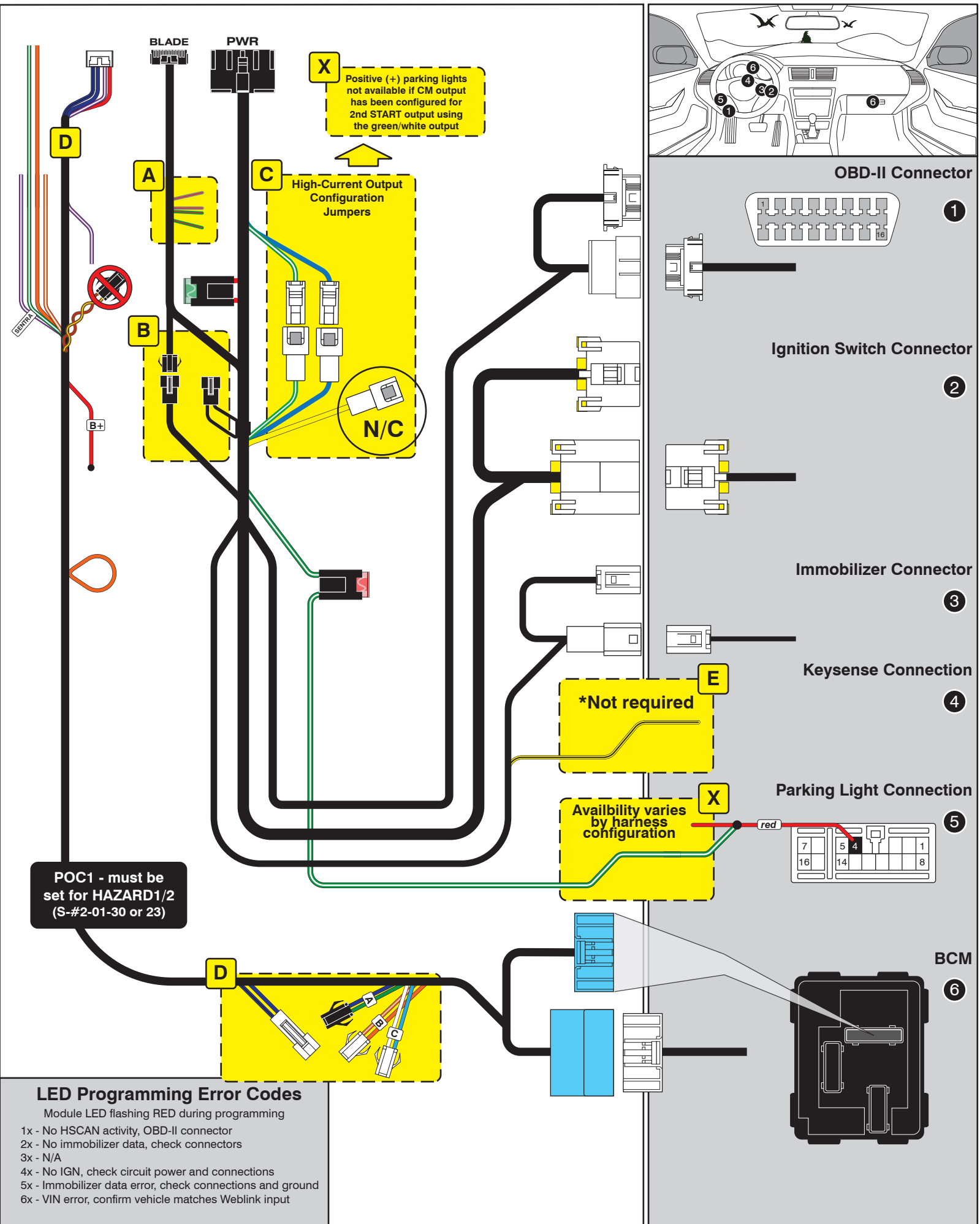

OBD-II Connector

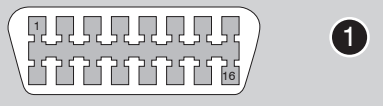

Ignition Switch Connector



Immobilizer Connector



Keysense Connection



Parking Light Connection

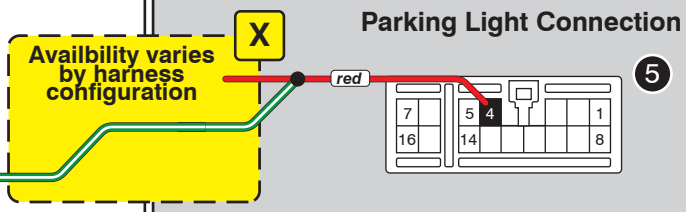

BCM

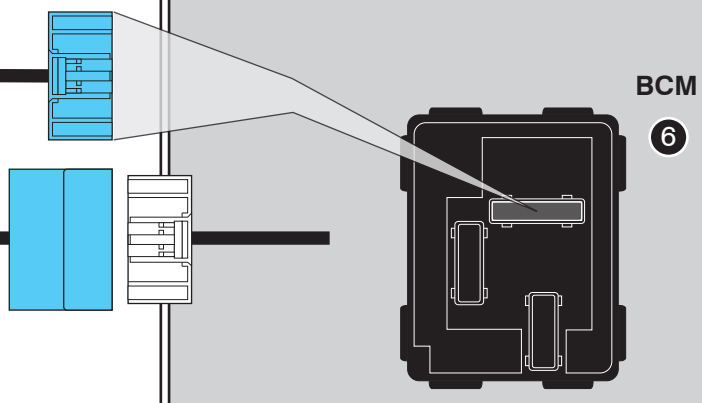

**POC1 - must be set for HAZARD1/2 (S-#2-01-30 or 23)**

**LED Programming Error Codes**

- Module LED flashing RED during programming
- 1x - No HSCAN activity, OBD-II connector
- 2x - No immobilizer data, check connectors
- 3x - N/A
- 4x - No IGN, check circuit power and connections
- 5x - Immobilizer data error, check connections and ground
- 6x - VIN error, confirm vehicle matches Weblink input

## CARTRIDGE INSTALLATION

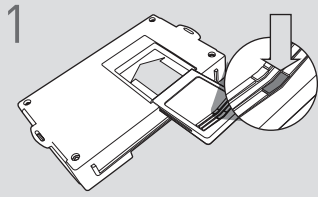

1 Slide cartridge into unit. Notice button under LED.

2

Ready for Module Programming Procedure.

## MODULE PROGRAMMING PROCEDURE

### NOTE

I To complete this procedure, use one regular key or one valet key.

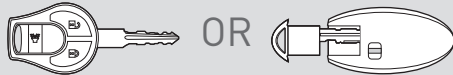

II When programming, all key fobs must be located at least 10 feet away from the vehicle.

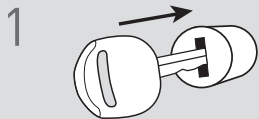
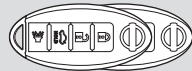

1 Insert key into ignition.

2

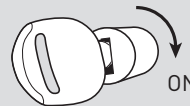

Turn key to ON position.

3

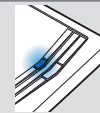

Wait, LED will turn solid BLUE for 2 seconds.

4

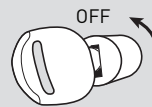

Turn key to OFF position.

5

Module Programming Procedure completed.