

Make	Model	Year	Install	IMMO	Lights	BCM	POC	I/O Changes
DL-HA3 Honda	Accord STD Key AT	2008-12	Type 1	Green	Park / Auto Type A	N/A	N/A	Green White/Blue N/A

Firmware:

Esta instalación requiere el firmware **BLADE-AL(DL)-HA3**, el módulo flash y la actualización del firmware del controlador antes de la instalación.

Instalación:

Los vehículos de **tipo 1** utilizan el adaptador inmovilizador **verde** de 7 pines.
El adaptador inmovilizador gris y el adaptador CN1 de 8 pines no se utilizan.

Luces:

(-) Las luces de estacionamiento y el apagado automático de la luz con el adaptador incluido requieren la modificación del conector CM I / O, quitando el cables de baja corriente (-) de estado negativo (**negro**) y luz de estacionamiento (**verde/blanco**), reemplazándolos con los cables preterminados del adaptador.

Esta instalación utiliza el conector **PRK LT A blanco**, asegure el conector PRK LT B no utilizado.

FTI-HDK2: Notas de instalación y configuración

- A** CONEXION REQUERIDA
- B** CONEXION REQUERIDA
- C** SE REQUIERE MODIFICACIÓN DEL CONECTOR
- D** SE REQUIERE CONFIGURACIÓN
- E** NO REQUERIDO



COBERTURA DE FUNCIONES															
<input type="checkbox"/>	<input type="checkbox"/>	<input type="checkbox"/>	<input type="checkbox"/>	<input type="checkbox"/>	<input type="checkbox"/>	<input type="checkbox"/>	<input type="checkbox"/>	<input type="checkbox"/>	<input type="checkbox"/>	<input type="checkbox"/>	<input type="checkbox"/>	<input type="checkbox"/>	<input type="checkbox"/>	<input type="checkbox"/>	<input type="checkbox"/>
IMMOBILIZER DATA	A/M CONTROL	DOOR LOCK	DOOR UNLOCK	ARM OEM ALARM	DISARM OEM ALARM	TRUNK/HATCH RELEASE					DOOR STATUS	TRUNK STATUS	HOOD STATUS	BRAKE STATUS	E-BRAKE STATUS
											TACH OUTPUT	AUTOLIGHT CTRL			PARKING LIGHTS

•FT-DAS Required for manual transmission.
•BOTH Red & Red/White MUST be connected with high current application.

Jumper Setting

Parking Light	Accessory	Ignition (Default)	(+)Door Trigger In (Default)	(-)Door Trigger In (Default)
Trunk	Starter	Parking Light (Default)	Starter	Ignition
			Accessory (Default)	

CM7000/7200 Cut loop for A/T

CM-900S/900AS

CM900AS/900S Jumper

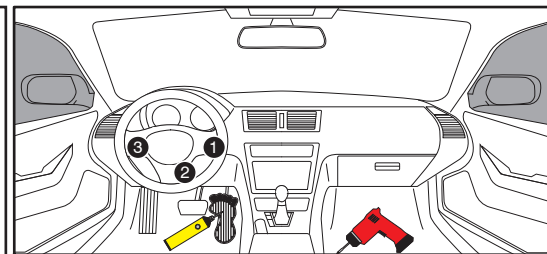
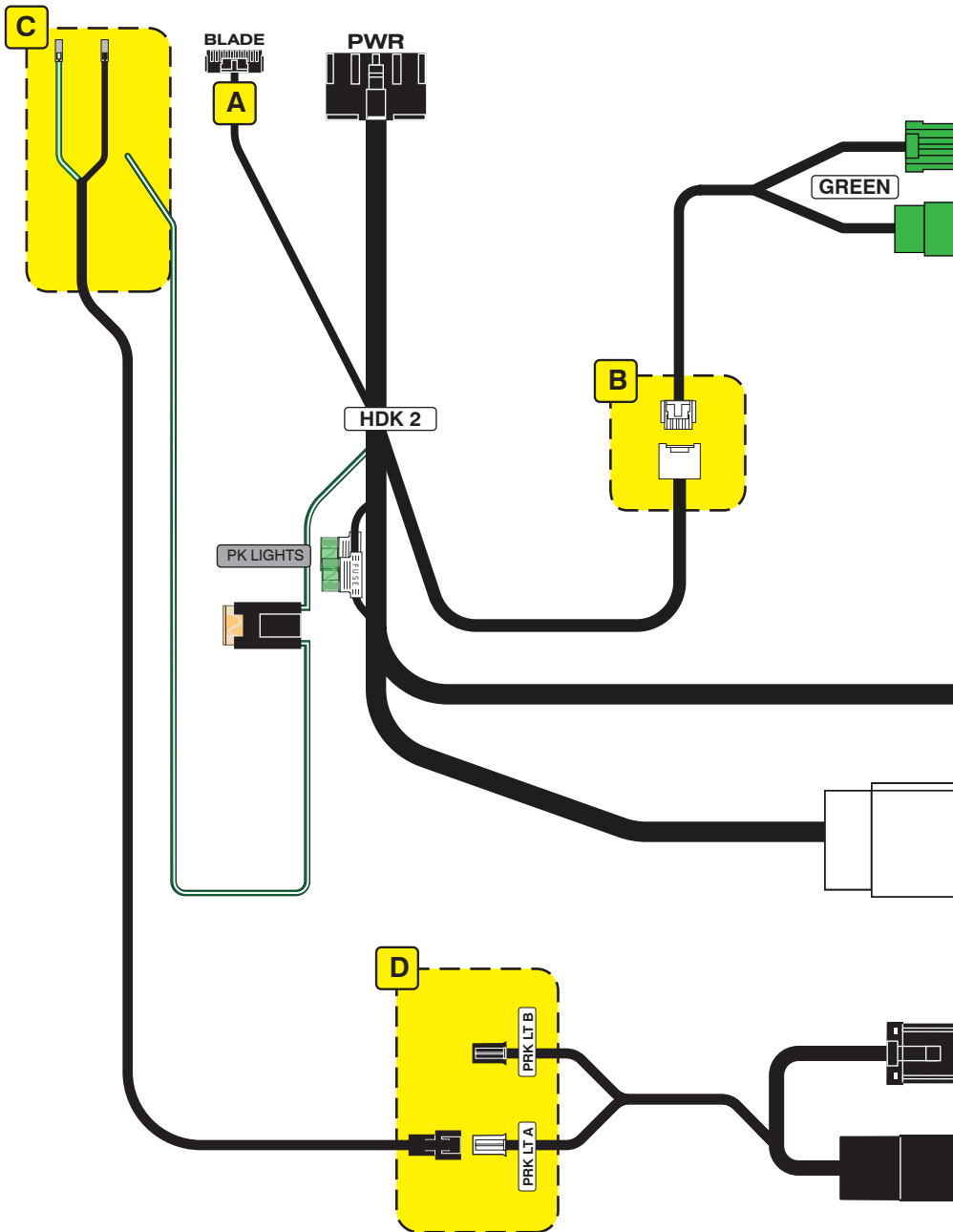

Immobilizer Connector

1

Ignition Switch

2

Headlight Switch Connector

3

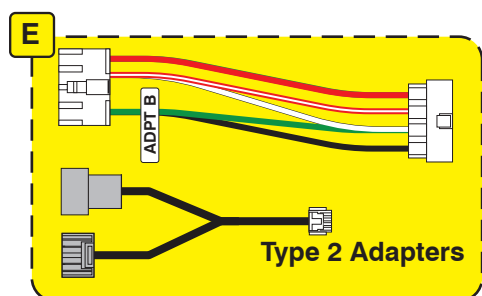
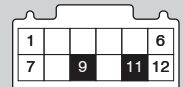

Códigos de error de programación de LED

El LED del módulo parpadea en ROJO durante la programación
1x - Error de CAN, confirme las conexiones al adaptador del inmovilizador

CARTRIDGE INSTALLATION

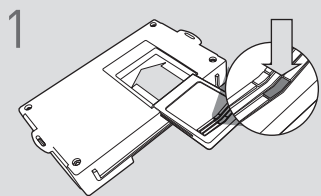

1 Slide cartridge into unit. Notice button under LED.

2

Ready for Module Programming Procedure.

MODULE PROGRAMMING PROCEDURE

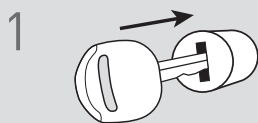

1 Insert key into ignition.



2 Turn key to ON position.

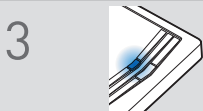

3 Wait, LED will turn solid BLUE for 2 seconds.



4 Turn key to OFF position.



5 Press UNLOCK on the OEM remote.



If the vehicle is equipped with a power liftgate: Open and close the power liftgate with the OEM keyfob.

6

Module Programming Procedure completed.