

FTI-HDK2: Vehicle Coverage and Preparation Notes

Make	Model	Year	Install	IMMO	Lights	BCM	POC	I/O Changes
DL-HA3 Acura	ZDX STD Key AT	2010-11	Type 1	Green	Park / Auto Type A	N/A	N/A	Green White/Blue N/A

Firmware:

This installation requires **BLADE-AL(DL)-HA3** firmware, flash module and update the controller firmware before the installation.

Install:

Type 1 vehicles use the **green 7-pin** immobilizer adapter. The gray immobilizer adapter and the 8-pin CN1 adapter are not used.

Lights:

(-) Parking lights and Auto-light shutoff using the included adapter requires modification of the CM I/O connector, removing the low current (-) negative status (black) and parking light (green/white) wires, replacing them with the pre-terminated wires of the adapter.

This installation uses the white **PRK LT A** connector, secure the unused PRK LT B connector.

FTI-HDK2: Installation and Configuration Notes

- A** CONNECTION REQUIRED
- B** CONNECTION REQUIRED
- C** CONNECTOR MODIFICATION REQUIRED
- D** CONFIGURATION REQUIRED
- E** NOT REQUIRED



FEATURE COVERAGE													
IMMOBILIZER DATA													
A/M CONTROL													
DOOR LOCK													
DOOR UNLOCK													
ARM OEM ALARM													
DISARM OEM ALARM													
TRUNK/HATCH RELEASE													
DOOR STATUS													
TRUNK STATUS													
HOOD STATUS													
BRAKE STATUS													
E-BRAKE STATUS													
TACH OUTPUT													
AUTOLIGHT CTRL													
PARKING LIGHTS													

- FT-DAS Required for manual transmission.
- BOTH Red & Red/White MUST be connected with high current application.

Jumper Setting

Parking Light	Accessory	Ignition (Default)	(+)Door Trigger In (Default)	(-)Door Trigger In (Default)
Trunk	Starter	Parking Light (Default)	Starter Ignition	Accessory (Default)

CM7000/7200 Cut loop for A/T

CM-900S/900AS

CM900AS/900S Jumper

START	ACC	IGN1
-------	-----	------

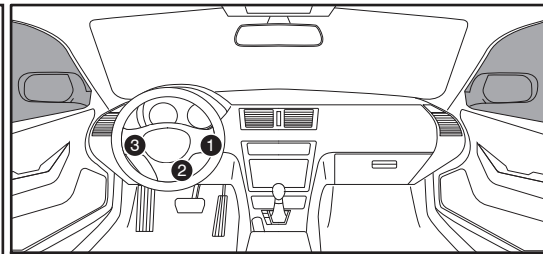
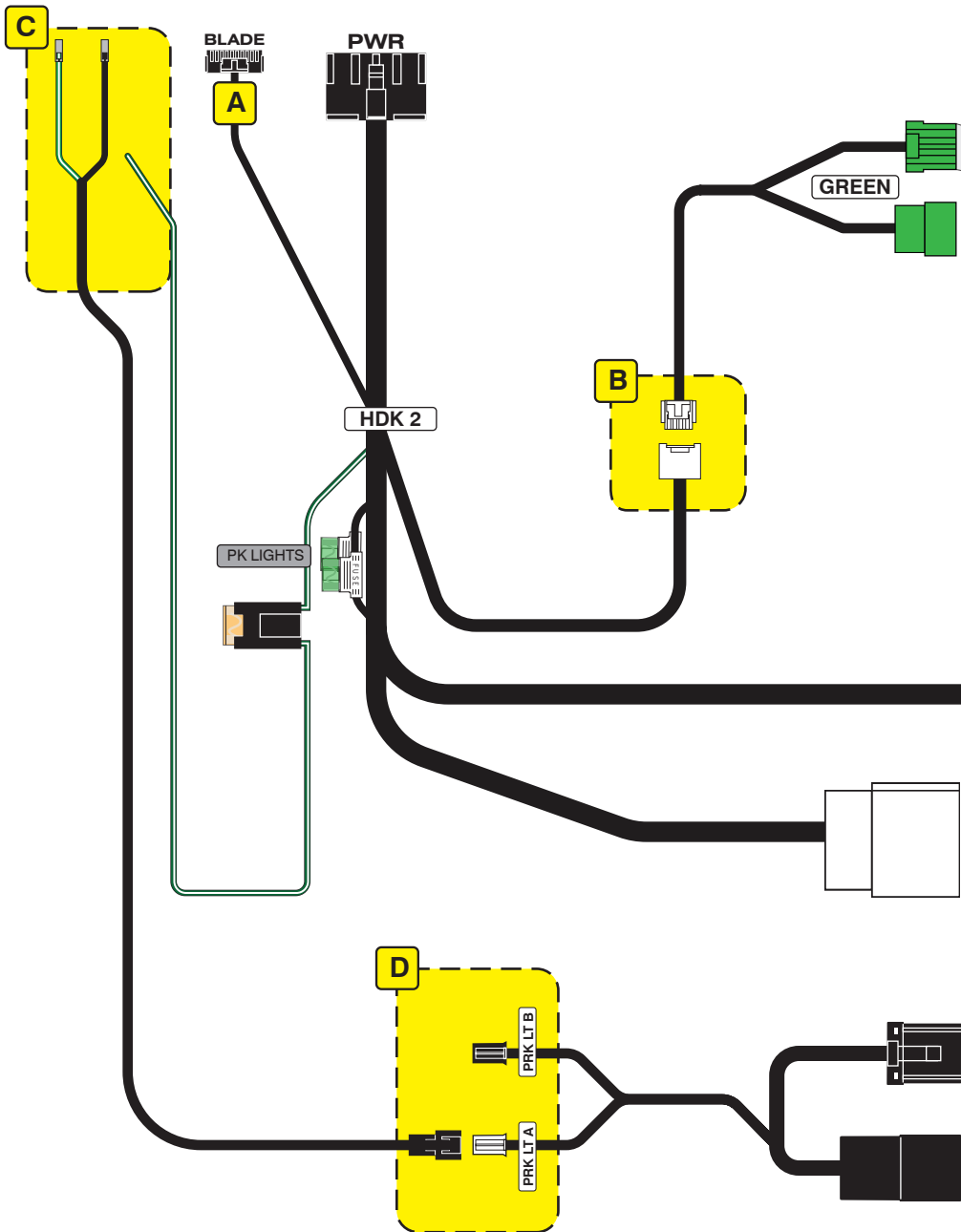

Immobilizer Connector

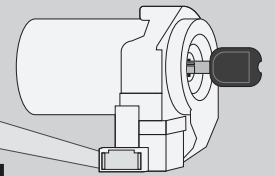

Ignition Switch

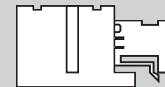

Headlight Switch Connector

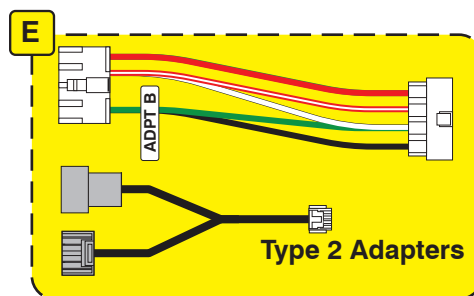
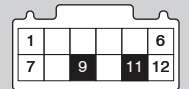

LED Programming Error Codes

Module LED flashing RED during programming
1x - CAN error, confirm connections to immobilizer adapter

CARTRIDGE INSTALLATION

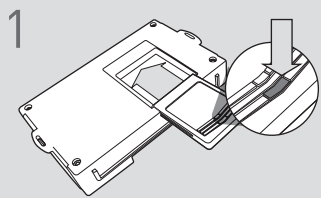

1 Slide cartridge into unit. Notice button under LED.

2

Ready for Module Programming Procedure.

MODULE PROGRAMMING PROCEDURE

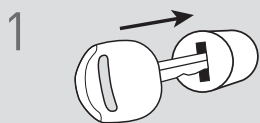

1 Insert key into ignition.



2 Turn key to ON position.

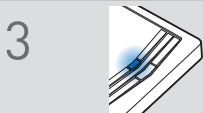

3 Wait, LED will turn solid BLUE for 2 seconds.



4 Turn key to OFF position.



5 Press UNLOCK on the OEM remote.



If the vehicle is equipped with a power liftgate: Open and close the power liftgate with the OEM keyfob.

6

Module Programming Procedure completed.