

Make	Model	Year	Install	Locks	Lights	IGN	POC	I/O Changes
DL-HA1 Honda	Accord STD Key	2003-07	Type 5	DATA	Park / Auto Red/Blk	Type A	N/A	Green White/Blue N/A

Esta instalación requiere **BLADE-AL(DL)-HA1**, módulo flash y actualizar el firmware del controlador antes de comenzar la instalación.

Luces: La provisión de arnés de luz de estacionamiento de + 12V (**verde / blanco**) se conecta al vehículo en el pin # 31 del conector blanco de 45 pines, ubicado en la parte delantera de la caja de fusibles, como se ilustra.

Control de arranque remoto de bloqueo 3X: El arnés HDK1 incluye un relé para proporcionar un control de bloqueo 3X del arrancador remoto. El **negro** cable etiquetado [ESTADO] proporciona control del relé del arnés conectado a los cables **blanco / rojo y blanco / negro**, que se utilizan para interrumpa el cable amarillo de encendido sin llave del vehículo durante el arranque remoto. Seleccione cualquier POC en el conector de E / S CM 7/9, retire el pin original y reemplácelo con el cable del arnés [ESTADO], establezca POC en ESTADO (5) en las opciones de POC.

Cerraduras de las puertas:

Las cerraduras de las puertas están cubiertas a través de datos, no se requieren conexiones adicionales. Conecte el mazo de cables **naranja a marrón / rojo** (patilla n. ° 4, conector verde de 21 clavijas) frente a la caja de fusibles, como se ilustra.

FTI-HDK1 - Notas de instalación y configuración

- A** CORTE REQUERIDO
- B** NO REQUERIDO
- C** CONEXION REQUERIDA
- D** CONEXIÓN REQUERIDA PARA ARRANQUE DE BLOQUEO 3X
- E** CONEXIÓN REQUERIDA PARA ARRANQUE DE BLOQUEO 3X



COBERTURA DE FUNCIONES															
IMMOBILIZER DATA															
DOOR LOCK															
DOOR UNLOCK															
ARM OEM ALARM															
DISARM OEM ALARM															
TRUNK/HATCH RELEASE															
DOOR STATUS															
TRUNK STATUS															
HOOD STATUS															
BRAKE STATUS															
E-BRAKE STATUS															
TACH OUTPUT															
A/M CONTROL															
AUTOLIGHT CTRL															
PARKING LIGHTS															

•FT-DAS Required for manual transmission.
•BOTH Red & Red/White MUST be connected with high current application.

Jumper Setting

Parking Light				(+)Door Trigger In
Accessory				(-)Door Trigger In
Ignition (Default)				(Default)
Trunk				Starter
Starter				Ignition
Parking Light (Default)				Accessory (Default)

CM7000/7200 **Cut loop for A/T**

CM-900S/900AS

CM900AS/900S Jumper

START
ACC
IGN1

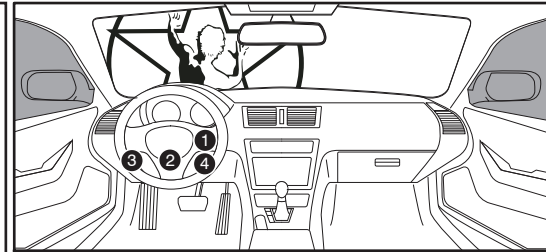
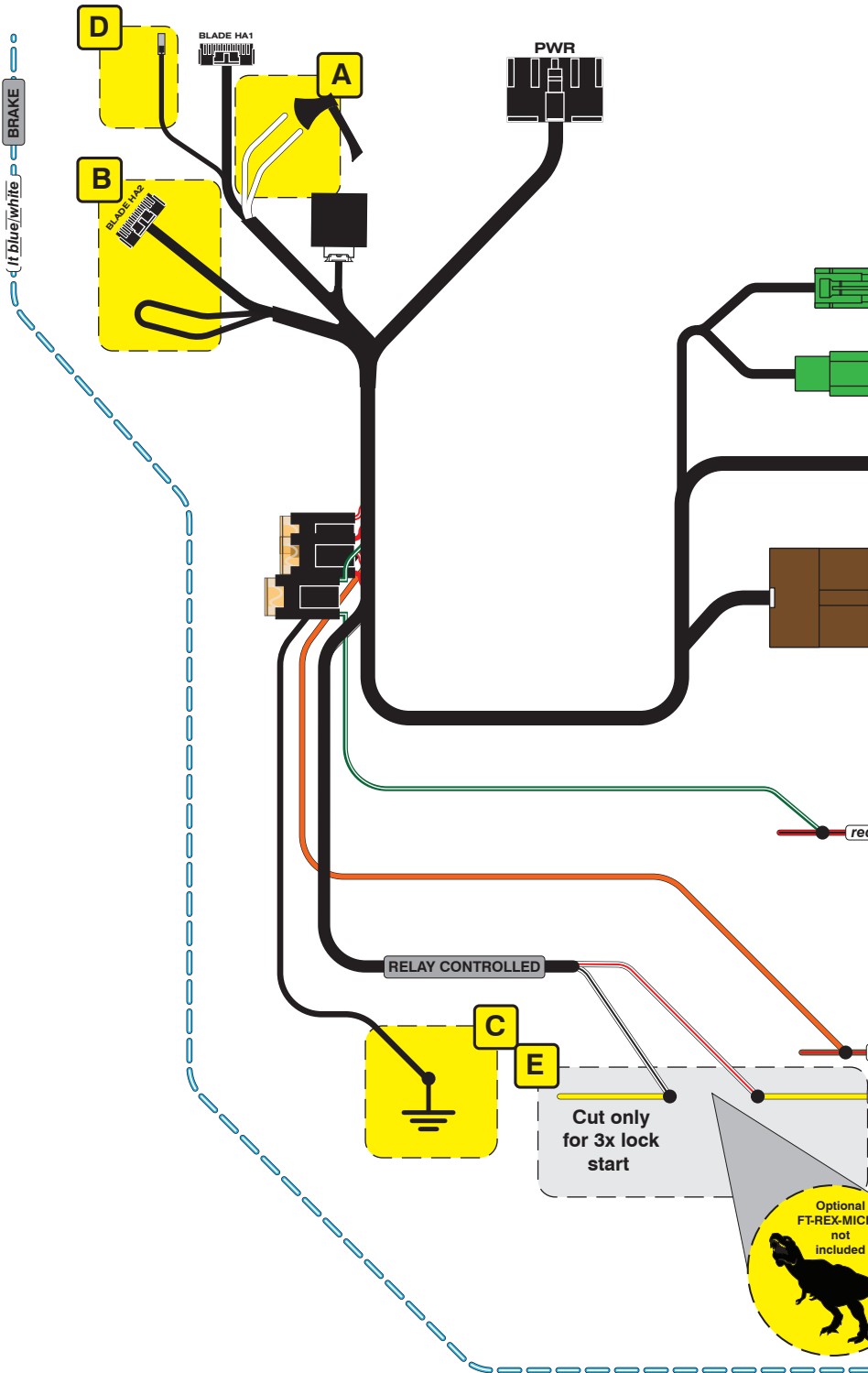

Immobilizer/Key Cylinder

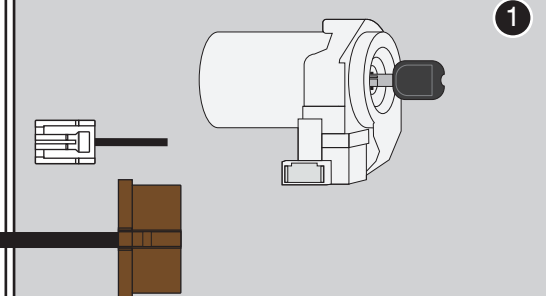

Ignition Switch Harness



Fuse Box

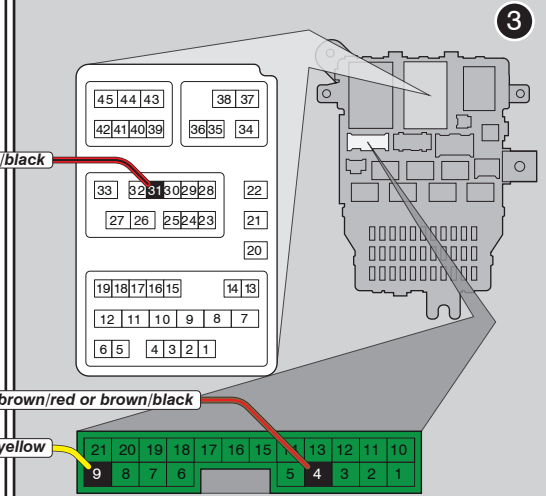

Brake Switch

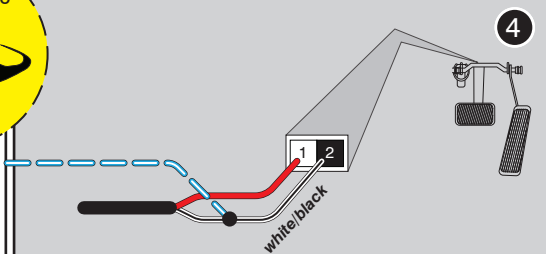

Códigos de error de programación de LED

El LED del módulo parpadea en ROJO durante la programación

- 1x - No hay actividad SWC (cerradura de puerta), verifique la conexión del cable naranja
- 2x - Error IMMO, verifique la conexión y la configuración del arnés (puentes)
- 3x - Error genérico, vamos ... es un arnés en T :)

CARTRIDGE INSTALLATION

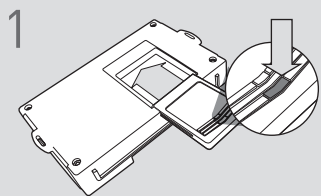

1 Slide cartridge into unit. Notice button under LED.

2

Ready for Module Programming Procedure.

MODULE PROGRAMMING PROCEDURE

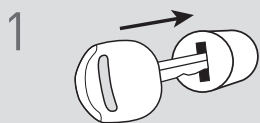

1 Insert key into ignition.



2 Turn key to ON position.

3

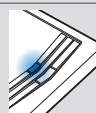

3 Wait, LED will turn solid BLUE for 2 seconds.

4

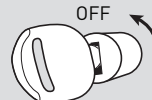

4 Turn key to OFF position.

5

5 Module Programming Procedure completed.