

Make	Model	Year	Install	Locks	Lights	IGN	POC	I/O Changes
DL-HA1 Acura	TSX STD Key	2004-08	Type 5	DATA	Park / Auto Red/Blk	Type A	N/A	Green White/Blue N/A

This installation requires **BLADE-AL(DL)-HA1**, flash module and update the controller firmware before beginning the installation.

Lights: +12V parking light harness provision (**green/white**) connects to the vehicle at pin #31 of the white 45-pin connector, located at the front of fuse box, as illustrated.

3X Lock Remote Start Control: The HDK1 harness includes a relay to provide 3X lock control of the remote starter. The black wire labeled [STATUS] provides control of the harness relay connected to the white/red & white/black wires, which are used to interrupt the vehicle yellow keyless ignition wire during remote start. Select any POC in the CM 7/9 I/O connector, remove the original pin and replace it with the harness [STATUS] wire, set POC to STATUS (5) in the POC options.

Door Locks:

Door locks are covered via data, no additional connections required. Connect harness **orange** wire to **brown/red** (pin #4, green 21-pin connector) front of fuse box, as illustrated.

FTI-HDK1 - Installation and Configuration Notes

- A** CUT REQUIRED
- B** NOT REQUIRED
- C** REQUIRED CONNECTION
- D** REQUIRED CONNECTION FOR 3X LOCK START
- E** REQUIRED CONNECTION FOR 3X LOCK START



FEATURE COVERAGE															
IMMOBILIZER DATA															
DOOR LOCK															
DOOR UNLOCK															
ARM OEM ALARM															
DISARM OEM ALARM															
TRUNK/HATCH RELEASE															
DOOR STATUS															
TRUNK STATUS															
HOOD STATUS															
BRAKE STATUS															
E-BRAKE STATUS															
TACH OUTPUT															
A/M CONTROL															
AUTOLIGHT CTRL															
PARKING LIGHTS															

FT-DAS Required for manual transmission.
BOTH Red & Red/White MUST be connected with high current application.

Jumper Setting

Parking Light	Accessory	Ignition (Default)	Trunk	Starter	Parking Light (Default)	(+)Door Trigger In (Default)	(-)Door Trigger In (Default)	Starter	Ignition	Accessory (Default)
---------------	-----------	--------------------	-------	---------	-------------------------	------------------------------	------------------------------	---------	----------	---------------------

CM7000/7200 Cut loop for A/T

CM-900S/900AS

CM900AS/900S Jumper

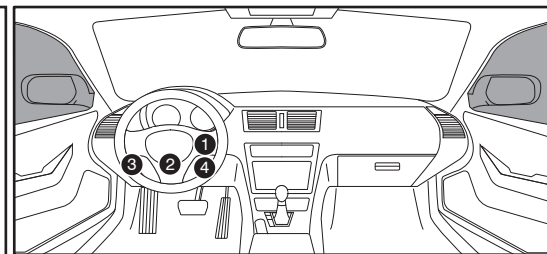
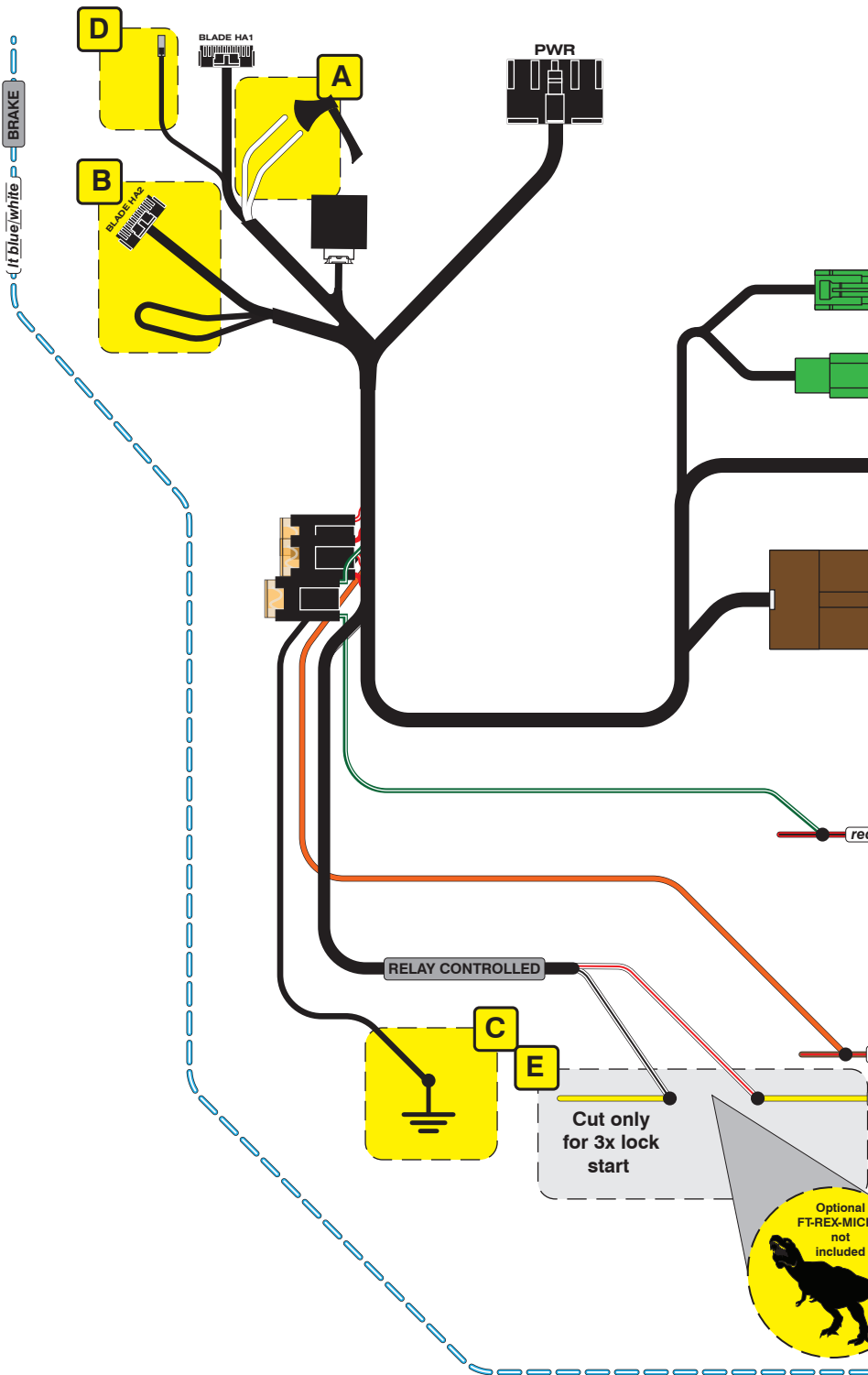

Immobilizer/Key Cylinder 1

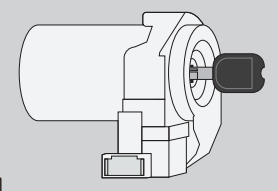

Ignition Switch Harness 2

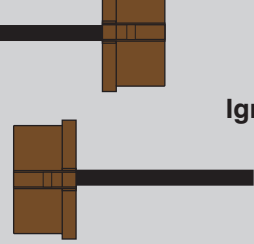

Fuse Box 3

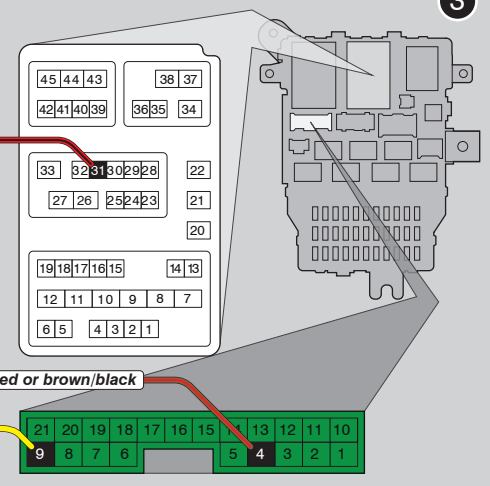

Brake Switch 4

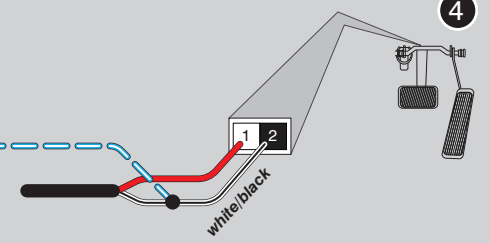

LED Programming Error Codes

- Module LED flashing RED during programming
- 1x - No SWC (doorlock) activity, check orange wire connection
 - 2x - IMMO error, check connection and harness configuration (jumpers)
 - 3x - Generic error, come on... it's a T-harness :)

CARTRIDGE INSTALLATION

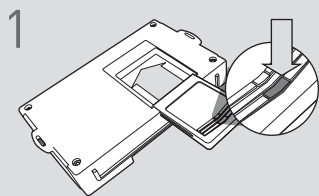

1 Slide cartridge into unit. Notice button under LED.

2

Ready for Module Programming Procedure.

MODULE PROGRAMMING PROCEDURE

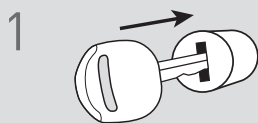

1 Insert key into ignition.



2 Turn key to ON position.

3

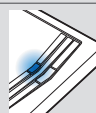

Wait, LED will turn solid BLUE for 2 seconds.

4

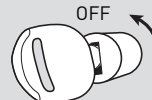

Turn key to OFF position.

5

Module Programming Procedure completed.