

Make	Model	Year	Install	Locks	Lights	IGN	POC	I/O Changes
DL-HA1 Acura	EL 1.7 STD Key with OEM Alarm	2001-05	Type 2	DATA	Park / Auto Blue	N/A	N/A	Green White/Blue N/A

Esta instalación requiere **BLADE-AL (DL) -HA1**, módulo flash y actualizar el firmware del controlador antes de comenzar la instalación.

Luces: La provisión de arnés de luz de estacionamiento de + 12V (**verde / blanco**) se conecta directamente al vehículo en el pin #5 del conector de 16 pines (**negro / blanco**) en el módulo sin llave, ubicado encima del panel de protección del conductor.

Tacómetro: **Azul** (patilla n. ° 5, conector verde de 13 patillas) en la parte delantera de la caja de fusibles, conéctelo como se muestra en la ilustración.

Freno: **Blanco / negro** (clavija n. ° 2, conector verde de 13 clavijas) frente a la caja de fusibles, conéctelo como se muestra en la ilustración.

Cerraduras de puertas: Las cerraduras de las puertas se cubren mediante datos en vehículos equipados con una alarma de fábrica. Conecte el arnés del cable **naranja** al vehículo cable **azul / naranja** (patilla n. ° 2, conector verde claro de 17 patillas), ubicado en la parte posterior de la caja de fusibles.

FTI-HDK1 - Notas de instalación y configuración

- A** CORTE REQUERIDO
- B** NO REQUERIDO
- C** CONEXION REQUERIDA
- D** NO REQUERIDO



COBERTURA DE FUNCIONES															
IMMOBILIZER DATA															
DOOR LOCK															
DOOR UNLOCK															
ARM OEM ALARM															
DISARM OEM ALARM															
TRUNK/HATCH RELEASE															
BRAKE STATUS															
TACH OUTPUT															
PARKING LIGHTS															

•FT-DAS Required for manual transmission.
•BOTH Red & Red/White MUST be connected with high current application.

Jumper Setting

Parking Light				(+)Door Trigger In
Accessory				(-)Door Trigger In
Ignition (Default)				
Trunk				Starter
Starter				Ignition
Parking Light (Default)				Accessory (Default)

CM7000/7200 Cut loop for A/T

CM-900S/900AS

CM900AS/900S Jumper

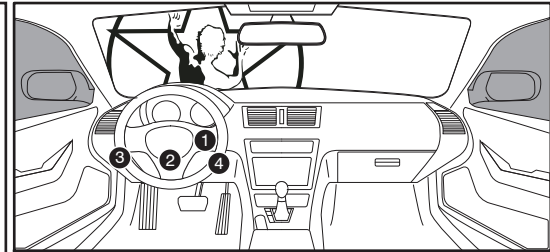
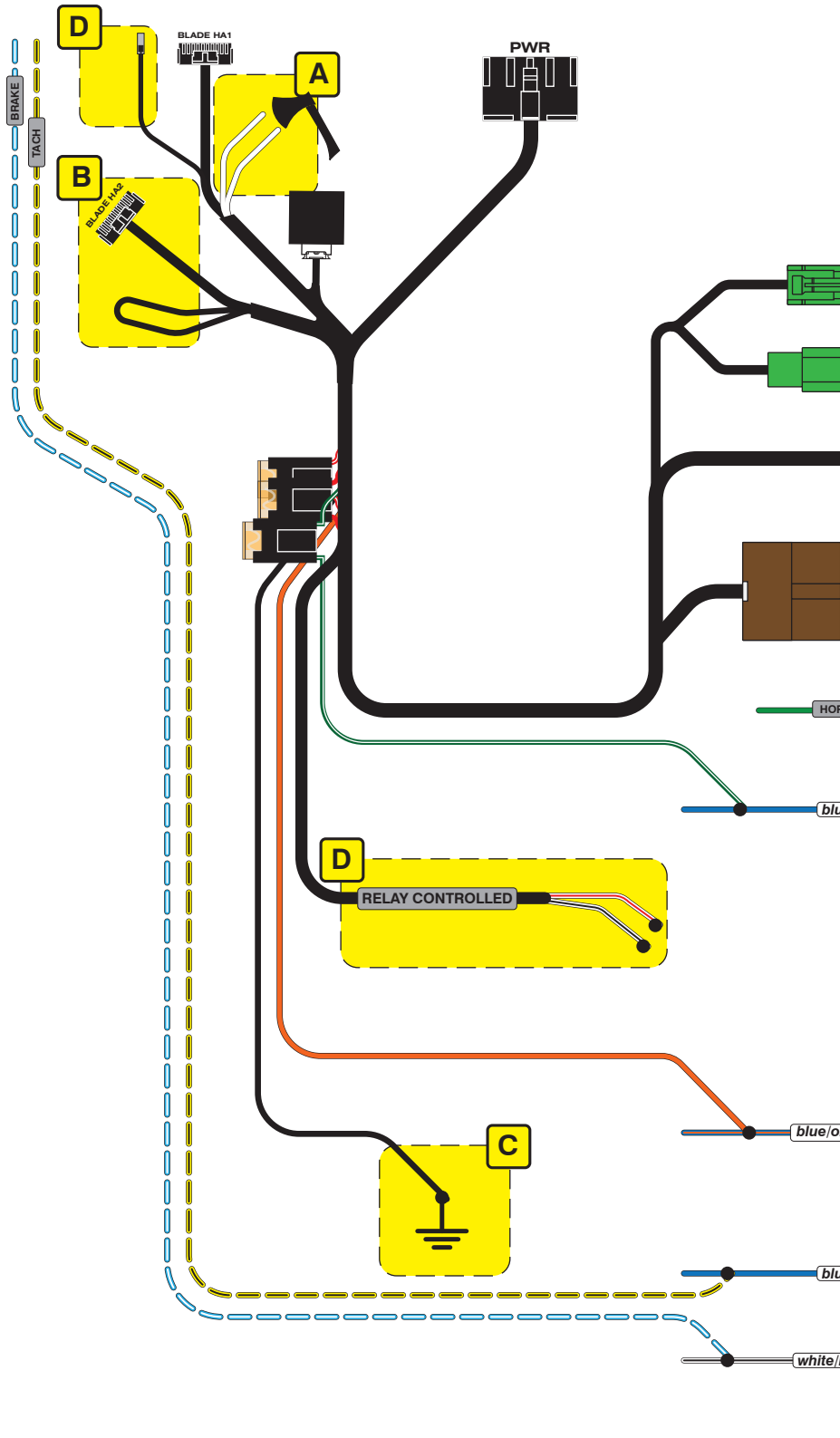

Immobilizer/Key Cylinder

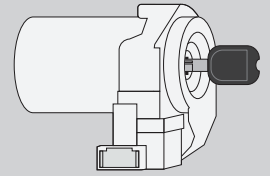

Ignition Switch Harness

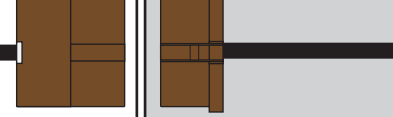

Keyless Module

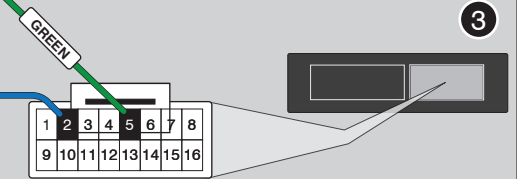

Fuse Box

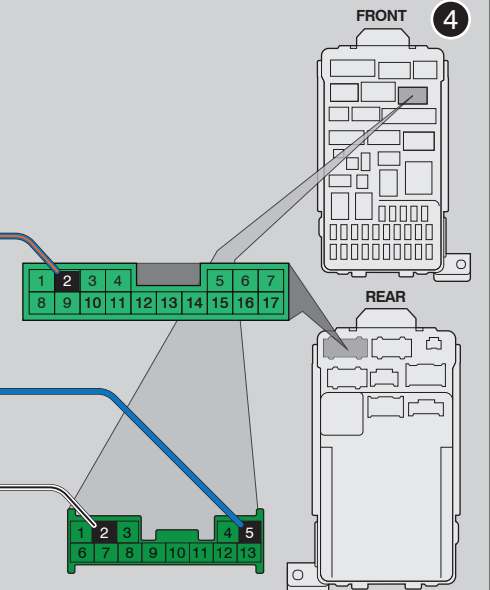

Códigos de error de programación de LED

El LED del módulo parpadea en ROJO durante la programación

- 1x - No hay actividad SWC (cerradura de puerta), verifique la conexión del cable naranja
- 2x - Error IMMO, verifique la conexión y la configuración del arnés (puentes)
- 3x - Error genérico, vamos ... es un arnés en T :)

CARTRIDGE INSTALLATION

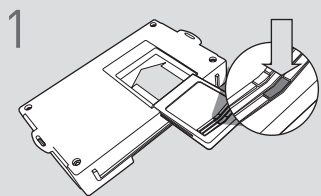

1 Slide cartridge into unit. Notice button under LED.

2

Ready for Module Programming Procedure.

MODULE PROGRAMMING PROCEDURE

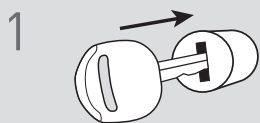

1 Insert key into ignition.



2 Turn key to ON position.

3

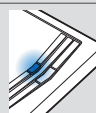

Wait, LED will turn solid BLUE for 2 seconds.

4

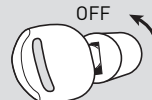

Turn key to OFF position.

5

Module Programming Procedure completed.