

Make	Model	Year	Install	CAN	Lights	OEM RS	POC	I/O Changes
DL-FM8					Park / Auto			Green White/Blue
Ford	Transit Connect PTS	2019-22	Type 5	GTWY	HAZ	N/A	N/A	N/A

Firmware: This installation requires **BLADE-AL(DL)-FM8** firmware, flash module and update the controller firmware before beginning the installation. This firmware requires the use of tach monitoring, please ensure that tach is programmed to avoid malfunction.

Harness headlight connector not compatible, configure POC for hazard lights [30] (momentary) or [23] (latched), connect to BCM connector C2280D (white 72-pin connector), pin #12 (brown/yellow).

Confirm vehicle compatibility on the module flashing site before proceeding with installation.

See compatibility note below.

Compatibility requirements: In order to confirm firmware compatibility, please confirm vehicle is equipped with active hood pin switch. Hood ajar warning must be displayed in instrument cluster when hood is open and ignition is on. Additional dealer programming and switch installation or hood ajar circuit manipulation* is required if hood ajar warning is not displayed when confirming.

FTI-FDK2: Installation and Configuration Notes

- A** BLUE MS CAN WIRES FOR PART 1 PROGRAMMING
- B** BROWN HS CAN WIRES FOR PART 2 PROGRAMMING
- C** SECURE UNUSED BLADE CONNECTOR TO MAIN HARNESS
- D** HOOD SWITCH MODIFICATION (Required if vehicle is not equipped with hood switch)



FEATURE COVERAGE												
IMMOBILIZER DATA												
DOOR LOCK												
DOOR UNLOCK												
ARM OEM ALARM												
DISARM OEM ALARM												
DOOR STATUS												
TRUNK STATUS												
RAP SHUTDOWN												
BRAKE STATUS												
HOOD STATUS												
TACH OUTPUT												
HEATED MIRRORS												
HEATED SEATS												
SECURE TAKEOVER												
PARKING LIGHTS												
REAR DEFROST												
AFTERMARKET CTRL												

•FT-DAS Required for manual transmission.
•BOTH Red & Red/White MUST be connected with high current application.

Jumper Setting

Parking Light				(+)Door Trigger In
Accessory				(-)Door Trigger In
Ignition (Default)				(Default)
Trunk				Starter
Starter				Ignition
Parking Light (Default)				Accessory (Default)

CM7000/7200 Cut loop for A/T

CM-900S/900AS

CM900AS/900S Jumper

START
ACC
IGN1

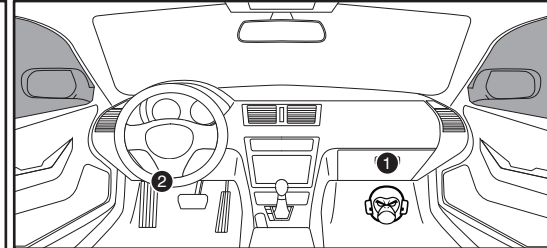
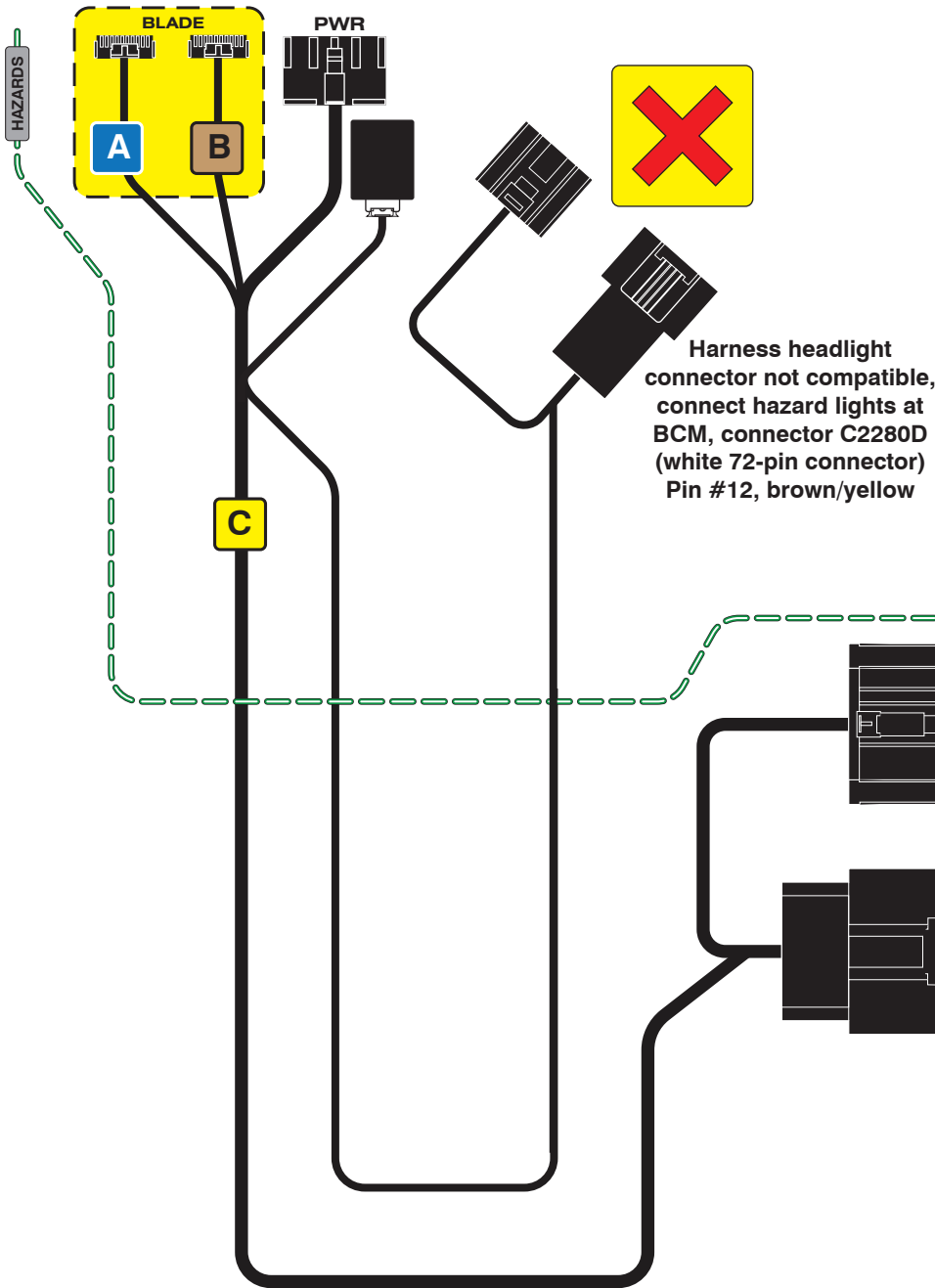

BCM
BCM, BEHIND GLOVE BOX
C2280D: WHITE 72 PIN

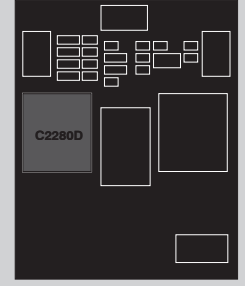

Gateway Module

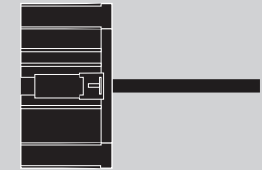
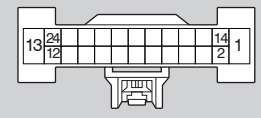

D IF THE VEHICLE IS NOT EQUIPPED WITH AN OEM HOOD SWITCH: CONNECT BLACK/PURPLE WIRE TO BLUE/ORANGE WIRE AT LATCH CONNECTOR, THEN INSTALL AN AFTERMARKET HOOD SWITCH.

BLACK

BLUE/ORANGE

BLACK/PURPLE

1 **2**

HOOD LATCH

LED Programming Error Codes

Module LED flashing RED during programming

- 1x - No CAN activity, confirm BLADE 1 or BLADE 2 connector
- 2x - No ignition, confirm BLADE 1 or BLADE 2 connector
- 3x - No communication with BCM, confirm compatibility
- 4x - Unable to activate OEM RS, confirm compatibility
- 5x - Unable to activate OEM RS, firmware will not work
- Fast Blink - CAN connection, reverse BLADE 1/2 connector

CARTRIDGE INSTALLATION



1 Slide cartridge into unit. Notice button under LED.

2

Ready for Module Programming Procedure.

MODULE PROGRAMMING PROCEDURE

1



CONNECT BLADE connector 'A', proceed with Step 1 programming

2

OFF ACC ON START

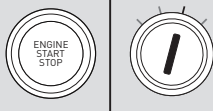

Set ignition to ON position.

3

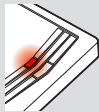

Wait, LED 1 will turn solid RED.

4



Wait, LED 1 will flash BLUE once [1x].

5

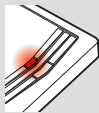

Wait, LED 1 will turn solid RED.

6

OFF ACC ON START

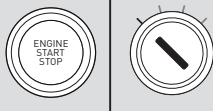

Set ignition to OFF position.

7



DISCONNECT BLADE connector 'A',
CONNECT BLADE connector 'B'.
proceed with Step 2 programming

8

OFF ACC ON START

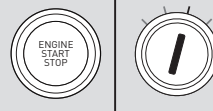

Set ignition to ON position.

9

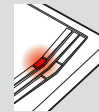

Wait, LED 1 will turn solid RED.

10

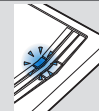

Wait, LED 1 will flash BLUE rapidly.

11

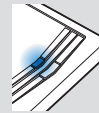

Wait, LED 1 will turn solid BLUE for 2 seconds.

12

OFF ACC ON START

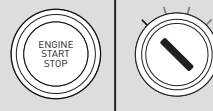

Set ignition to OFF position.

13

Module Programming Procedure completed.

TAKE OVER PROCEDURE - TO THE VEHICLE OWNER

NOTE

- I All vehicle doors must be closed and locked prior to remote start sequence.

1



Press unlock on OEM or aftermarket remote or request switch.

2



DO NOT PRESS BRAKE PEDAL. Set ignition to ON position. Wait 2 seconds for key validation.

3



Press and release BRAKE pedal.

4

Take over procedure completed.



Failure to follow procedure will result in vehicle engine shutdown.