

# FTI-FDK2: Vehicle Coverage and Preparation Notes

Make	Model	Year	Install	CAN	Lights	OEM RS	POC	I/O Changes
<b>DL-FM8</b>					<b>Park / Auto</b>			<b>Green White/Blue</b>
Ford	Escape STD Key AT	2020-21	Type 7	GTWY	HAZ	N/A	N/A	N/A

**Firmware:** This installation requires **BLADE-AL(DL)-FM8** firmware, flash module and update the controller firmware before beginning the installation. This firmware requires the use of tach monitoring, please ensure that tach is programmed to avoid malfunction.

Harness headlight connector not compatible, configure POC for hazard lights [30] (momentary) or [23] (latched), connect to BCM connector C2280D (white 72-pin connector), pin #12 (brown/yellow).

Confirm vehicle compatibility on the module flashing site before proceeding with installation.

See compatibility note below.

**Compatibility requirements:** In order to confirm firmware compatibility, please confirm vehicle is equipped with active hood pin switch. Hood ajar warning must be displayed in instrument cluster when hood is open and ignition is on. Additional dealer programming and switch installation or hood ajar circuit manipulation\* is required if hood ajar warning is not displayed when confirming.

## FTI-FDK2: Installation and Configuration Notes

- A** BLUE MS CAN WIRES FOR PART 1 PROGRAMMING
- B** BROWN HS CAN WIRES FOR PART 2 PROGRAMMING
- C** SECURE UNUSED BLADE CONNECTOR TO MAIN HARNESS
- D** HOOD SWITCH MODIFICATION (Required if vehicle is not equipped with hood switch)



FEATURE COVERAGE												
IMMOBILIZER DATA												
DOOR LOCK												
DOOR UNLOCK												
ARM OEM ALARM												
DISARM OEM ALARM												
DOOR STATUS												
TRUNK STATUS												
RAP SHUTDOWN												
BRAKE STATUS												
HOOD STATUS												
TACH OUTPUT												
HEATED MIRRORS												
HEATED SEATS												
SECURE TAKEOVER												
PARKING LIGHTS												
REAR DEFROST												
AFTERMARKET CTRL												

•FT-DAS Required for manual transmission.  
•BOTH Red & Red/White MUST be connected with high current application.

**Jumper Setting**

Parking Light				(+)Door Trigger In
Accessory				(-)Door Trigger In
Ignition (Default)				(Default)
Trunk				Starter
Starter				Ignition
Parking Light (Default)				Accessory (Default)

**CM7000/7200** Cut loop for A/T

**CM-900S/900AS**

**CM900AS/900S Jumper**

START  
ACC  
IGN1

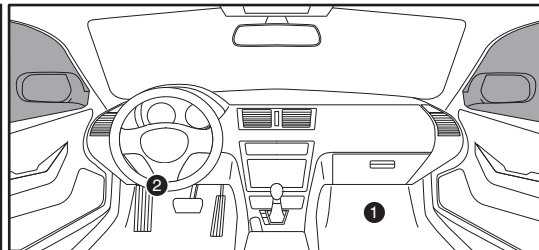
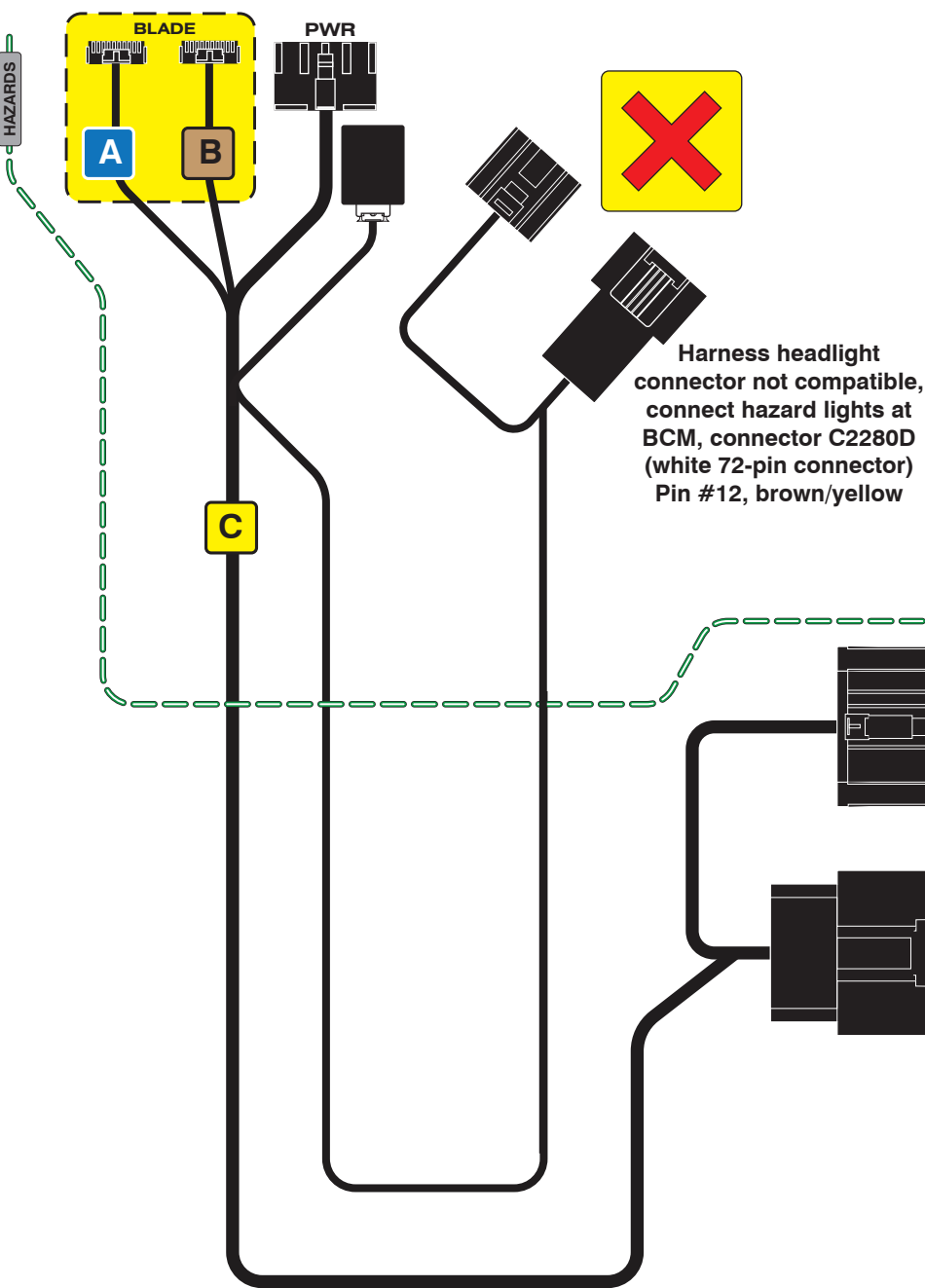

**BCM**  
BCM, PASSENGER FOOTWELL  
C2280D: WHITE 72 PIN

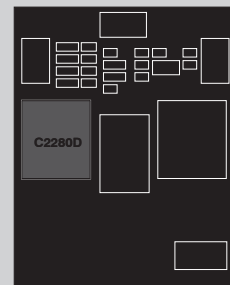

**Gateway Module**

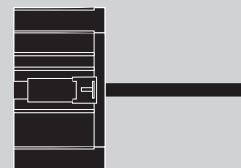
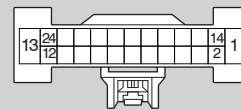

**D** IF THE VEHICLE IS NOT EQUIPPED WITH AN OEM HOOD SWITCH: CONNECT BLACK/PURPLE WIRE TO BLUE/ORANGE WIRE AT LATCH CONNECTOR, THEN INSTALL AN AFTERMARKET HOOD SWITCH.

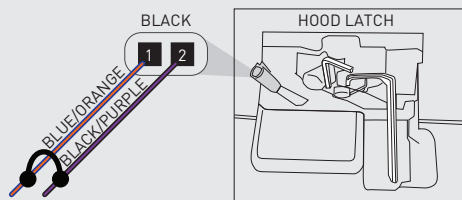

**LED Programming Error Codes**

Module LED flashing RED during programming

- 1x - No CAN activity, confirm BLADE 1 or BLADE 2 connector
- 2x - No ignition, confirm BLADE 1 or BLADE 2 connector
- 3x - No communication with BCM, confirm compatibility
- 4x - Unable to activate OEM RS, confirm compatibility
- 5x - Unable to activate OEM RS, firmware will not work
- Fast Blink - CAN connection, reverse BLADE 1/2 connector

## CARTRIDGE INSTALLATION



1 Slide cartridge into unit. Notice button under LED.

2

Ready for Module Programming Procedure.

## MODULE PROGRAMMING PROCEDURE



1 CONNECT BLADE connector 'A', proceed with Step 1 programming

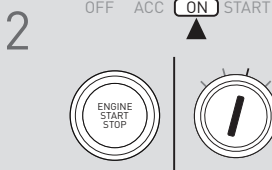

2 Set ignition to ON position.



3 Wait, LED 1 will turn solid RED.

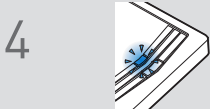

4 Wait, LED 1 will flash BLUE once [1x].



5 Wait, LED 1 will turn solid RED.



6 Set ignition to OFF position.



7 DISCONNECT BLADE connector 'A', CONNECT BLADE connector 'B', proceed with Step 2 programming

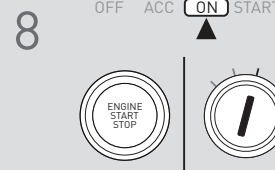

8 Set ignition to ON position.



9 Wait, LED 1 will turn solid RED.



10 Wait, LED 1 will flash BLUE rapidly.



11 Wait, LED 1 will turn solid BLUE for 2 seconds.



12 Set ignition to OFF position.

13

Module Programming Procedure completed.

## TAKE OVER PROCEDURE - TO THE VEHICLE OWNER

### NOTE

- I All vehicle doors must be closed and locked prior to remote start sequence.

1



Press unlock on OEM or aftermarket remote or request switch.

2

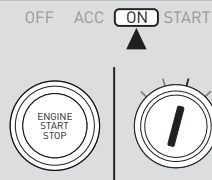

DO NOT PRESS BRAKE PEDAL. Set ignition to ON position. Wait 2 seconds for key validation.

3



Press and release BRAKE pedal.

4

Take over procedure completed.



Failure to follow procedure will result in vehicle engine shutdown.