

Make	Model	Year	Install	CAN	Lights	IGN	RAP	I/O Changes
DL-CH12 RAM	3500 PTS	2019-22	Type 4	CJB	Park / Auto Type B	PINK	NO	Green White/Blue N/A

### FIRMWARE:

This installation requires BLADE-AL(DL)-CH12, flash module and update the controller firmware before installing.

### INSTALLATION:

Type 4 vehicles use the included CAN extension cable to source CAN data from the green CAN junction block, located behind the headlight switch

### LIGHTS:

Type B parking lights use the harness 10-pin MUX provision, the harness 6-pin connectors is not used. Please ensure that it is properly secured for safety.

### IGNITION:

Type 4 ignition is available at the trailer module connector (TMC), located to the right of the steering column in the gray 10-pin connector (pin #10, pink/green).



## FTI-CDP1 - Installation and Configuration Notes

- A** REQUIRED CONFIGURATION (PINK)
- B** REQUIRED CONNECTION (CAN extension cable)
- C** NOT REQUIRED (OBD CAN)
- D** REQUIRED CONNECTION (IGN)

•FT-DAS Required for manual transmission.  
•BOTH Red & Red/White MUST be connected with high current application.

**Jumper Setting**

Parking Light	Accessory	Ignition (Default)	(+)Door Trigger In (Default)	(-)Door Trigger In (Default)
Trunk	Starter	Parking Light (Default)	Starter	Ignition
			Accessory (Default)	

**CM7000/7200** Cut loop for A/T

**CM-900S/900AS**

**CM900AS/900S Jumper**

**START  
ACC  
IGN1**



FEATURE COVERAGE																				
IMMOBILIZER DATA	ARM OEM ALARM	DISARM OEM ALARM	DOOR LOCK	DOOR UNLOCK	PRIORITY UNLOCK	TRUNK/HATCH RELEASE	POWER LIFTGATE	POWER SLIDING DOOR (L)	POWER SLIDING DOOR (R)	SECURE TAKEOVER	DOOR STATUS	TRUNK STATUS	HOOD STATUS	E-BRAKE STATUS	TACH OUTPUT	BRAKE STATUS	GLOW PLUG STATUS	PARKING LIGHTS	HAZARD LIGHTS	A/M CONTROL

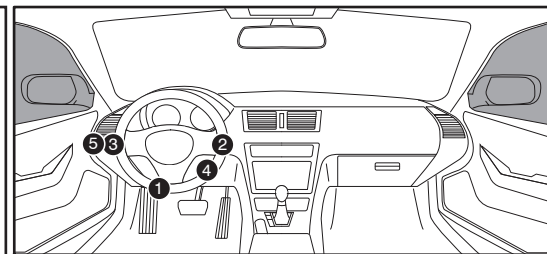
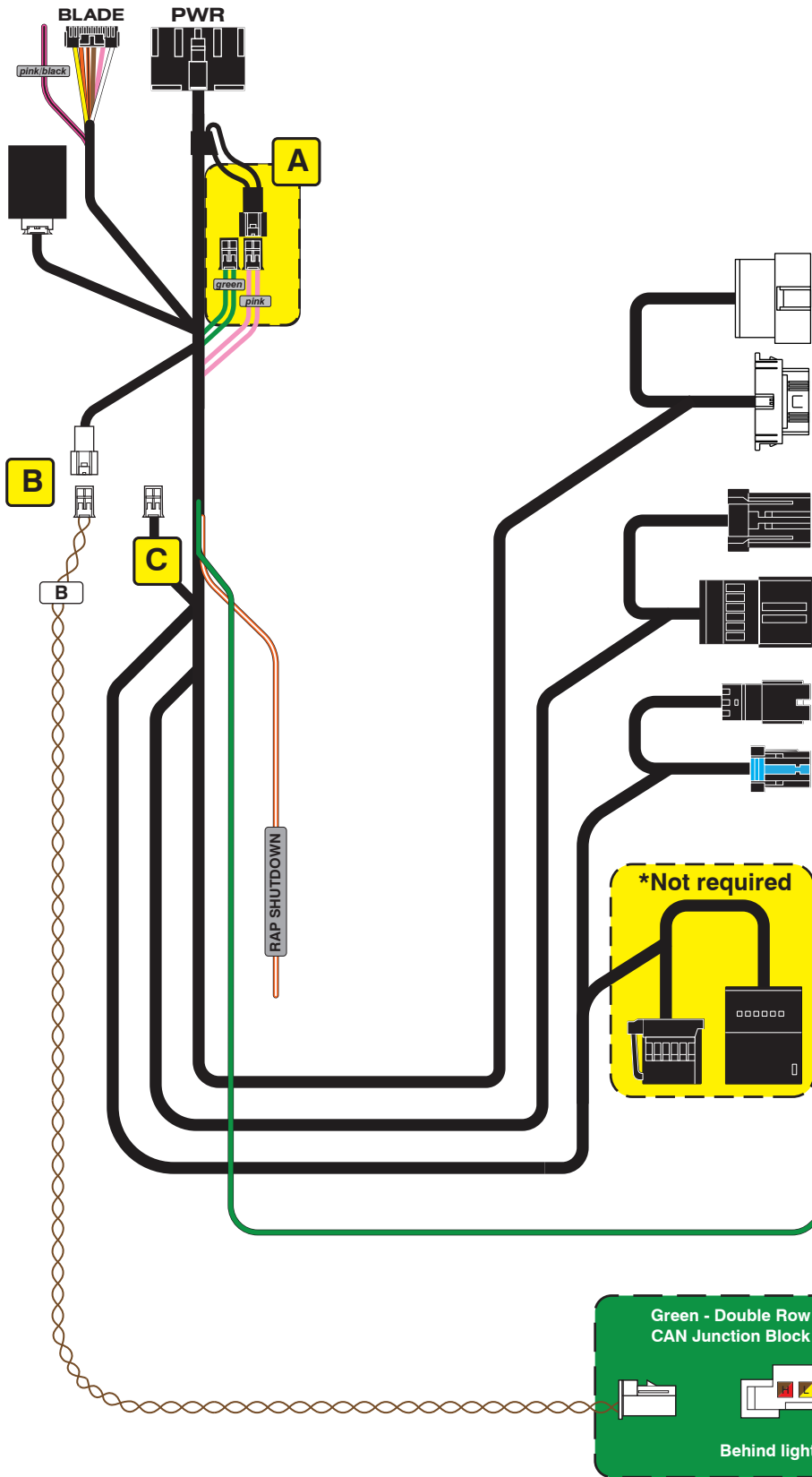

**OBD-II connector**

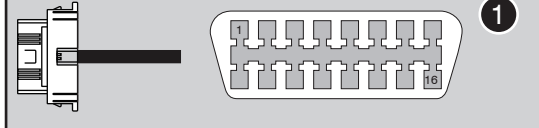

**PTS Button**



**Headlight switch**

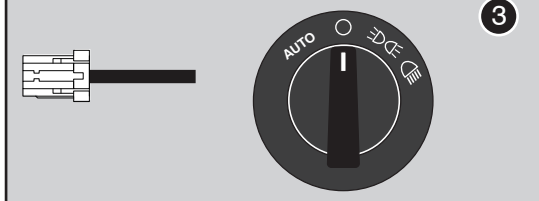

**Trailer Module Connector**

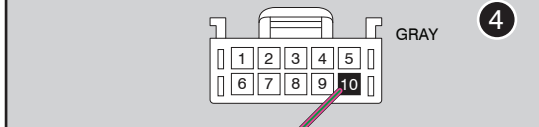

pink/green

**CAN Junction Block (behind light switch)**

**Green CAN-C Junction Block**

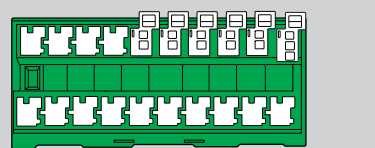

**LED Programming Error Codes**

Module LED flashing RED during programming

- 1x - CAN Error
- 2x - Key code not learned
- 3x - No IGNITION
- 4x - No immobilizer, check CAN/key
- 5x - VIN error, check CAN wiring
- 6x - See 4x error
- 7x - KLON error
- 8x - No IGNITION, check connection

## MODULE PROGRAMMING PROCEDURE - PTS

### NOTE

I **IMPORTANT:** The hood must be closed.

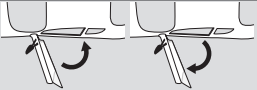
1  Close driver door.  
Re-open driver door to wake up data bus.

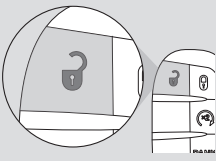
2  Press UNLOCK on OEM remote.  
  
(If the vehicle is not equipped with an OEM remote, press on the module programming button.)

3  Wait, LED will flash BLUE once [1x]. If LED does not flash GREEN, repeat step 2.

4  Set ignition to ON position.

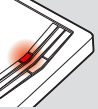

5  Wait, if LED turns solid RED proceed to step 6.  
If LED flashes BLUE rapidly, proceed to step 10.

6  Set ignition to OFF position.



7  Repeat steps 4 to 6, eight times [8x].

8  Set ignition to ON position.

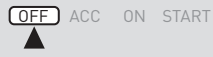

9  Wait, LED will flash BLUE rapidly.

10  Set ignition to OFF position.

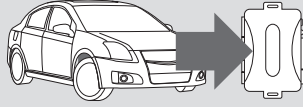

11  **WARNING:**  
Disconnect power last.  
Disconnect module from vehicle.

12  Connect module to computer and proceed with extended programming.

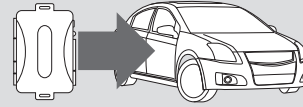
13  **WARNING:** Do not press module programming button.  
Connect power first.  
Connect module to vehicle.

14  Set ignition to ON position.

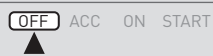

15  Wait, LED will turn solid BLUE for 2 seconds.

16  Set ignition to OFF position.



17 **Module Programming Procedure completed.**

## WARNING: READ BEFORE REMOTE STARTING THE VEHICLE

### IMPORTANT

- I All vehicle doors must be closed and locked prior to remote start sequence. Failure to comply will result in remote starter malfunction.

## TAKE OVER PROCEDURE - PTS - TO THE VEHICLE OWNER

### NOTE

- I All vehicle doors must be closed and locked prior to remote start sequence.



**TIME RESTRICTION COMING UP !**

1



Unlock vehicle door using OEM or after-market remote, or door request switch.

2

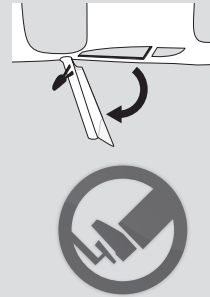

### TIME RESTRICTION

Within 45 SECONDS from previous step:

Open vehicle door.  
Enter vehicle.  
Close vehicle door.

Press and release BRAKE pedal.

3

Take over procedure completed.



Failure to follow procedure will result in vehicle engine shutdown.