

Make	Model	Year	Install	CAN	Lights	IGN	RAP	I/O Changes
DL-CH12 RAM	3500 Diesel PTS	2019-22	Type 4	CJB	Park / Auto B	PINK	NO	Green White/Blue N/A

FIRMWARE:

Esta instalación requiere BLADE-AL (DL) -CH12, módulo flash y actualización del firmware del controlador antes de la instalación.

INSTALACIÓN:

Los vehículos de tipo 4 utilizan el cable de extensión CAN incluido para obtener datos CAN del bloque de conexiones CAN verde, ubicado detrás del interruptor del faro.

LUCES:

Las luces de estacionamiento tipo B usan la disposición MUX de 10 pines del arnés, los conectores de 6 pines del arnés no se usan. Asegúrese de que esté debidamente asegurado por seguridad.

ENCENDIDO:

El encendido Tipo 4 está disponible en el conector del módulo del remolque (TMC), ubicado a la derecha de la columna de dirección en el conector gris de 10 pines (pin # 10, rosa / verde).

FTI-CDP1 - Notas de instalación y configuración

- A** CONFIGURACIÓN REQUERIDA (ROSA)
- B** CONEXIÓN REQUERIDA (cable de extensión CAN)
- C** NO REQUERIDA (OBD CAN)
- D** CONEXIÓN REQUERIDA (IGN)



COBERTURA DE FUNCIONES																				
IMMOBILIZER DATA	ARM OEM ALARM	DISARM OEM ALARM	DOOR LOCK	DOOR UNLOCK	PRIORITY UNLOCK	TRUNK/HATCH RELEASE	POWER LIFTGATE	POWER SLIDING DOOR (L)	POWER SLIDING DOOR (R)	SECURE TAKEOVER	DOOR STATUS	TRUNK STATUS	HOOD STATUS	E-BRAKE STATUS	TACH OUTPUT	BRAKE STATUS	GLOW PLUG STATUS	PARKING LIGHTS	HAZARD LIGHTS	A/M CONTROL

•FT-DAS Required for manual transmission.
•BOTH Red & Red/White MUST be connected with high current application.

Jumper Setting

CM7000/7200 Cut loop for A/T

CM-900S/900AS

CM900AS/900S Jumper

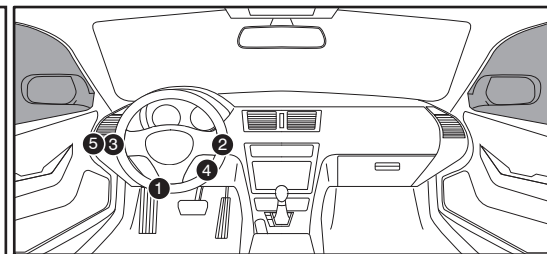
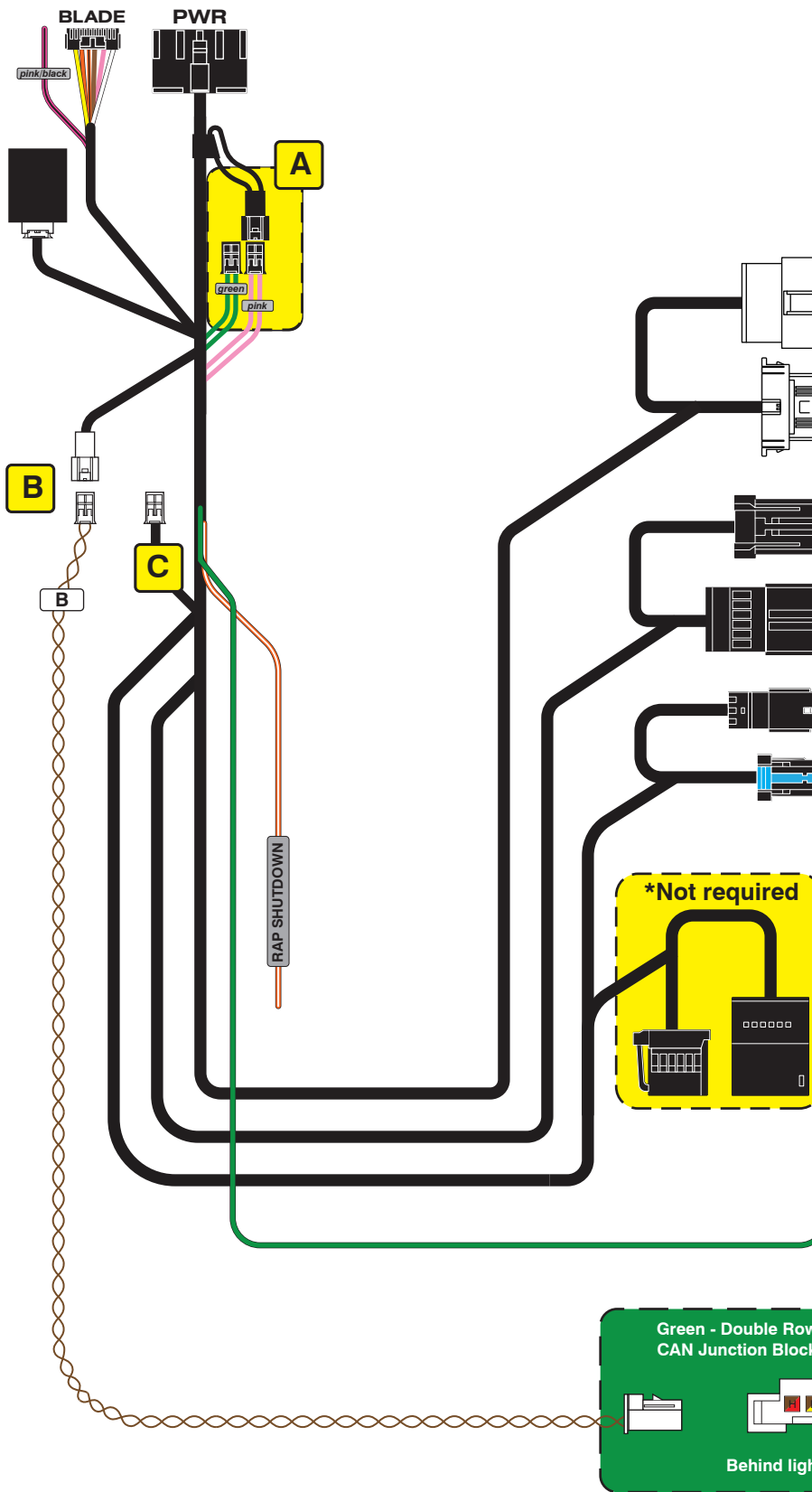

OBD-II connector

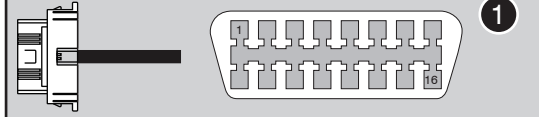

PTS Button



Headlight switch

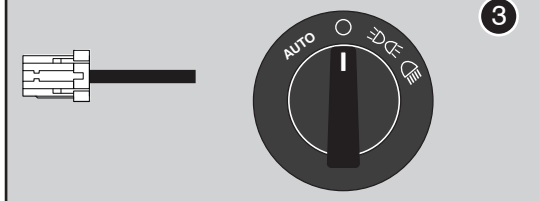

Trailer Module Connector

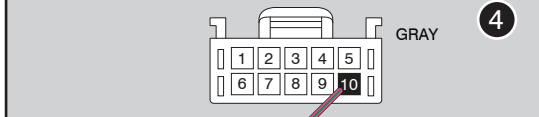

CAN Junction Block (behind light switch)

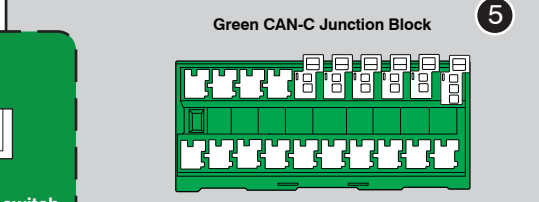

Códigos de error de programación de LED
El LED del módulo parpadea en ROJO durante la programación

- 1x - Error de CAN
- 2x - Código clave no aprendido
- 3x - Sin ENCENDIDO
- 4x - Sin inmovilizador, comprobar CAN / llave
- 5x - Error de VIN, verifique el cableado CAN
- 6x - Ver error 4x
- 7x - Error de KLON
- 8x - Sin ENCENDIDO, verifique la conexión

MODULE PROGRAMMING PROCEDURE - PTS

NOTE

I **IMPORTANT:** The hood must be closed.

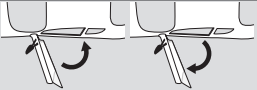
1  Close driver door.
Re-open driver door to wake up data bus.

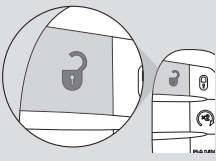
2  Press UNLOCK on OEM remote.

(If the vehicle is not equipped with an OEM remote, press on the module programming button.)

3  Wait, LED will flash BLUE once [1x]. If LED does not flash GREEN, repeat step 2.

4  Set ignition to ON position.

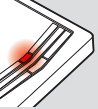

5  Wait, if LED turns solid RED proceed to step 6.
If LED flashes BLUE rapidly, proceed to step 10.

6  Set ignition to OFF position.



7  Repeat steps 4 to 6, eight times [8x].

8  Set ignition to ON position.

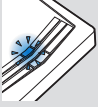

9  Wait, LED will flash BLUE rapidly.

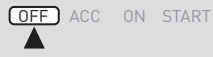
10  Set ignition to OFF position.

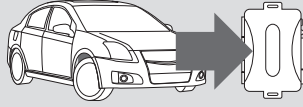

11  **WARNING:**
Disconnect power last.
Disconnect module from vehicle.

12  Connect module to computer and proceed with extended programming.

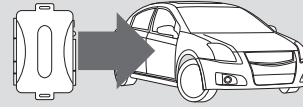
13  **WARNING:** Do not press module programming button.
Connect power first.
Connect module to vehicle.

14  Set ignition to ON position.

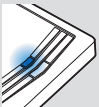

15  Wait, LED will turn solid BLUE for 2 seconds.

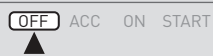
16  Set ignition to OFF position.



17 **Module Programming Procedure completed.**

WARNING: READ BEFORE REMOTE STARTING THE VEHICLE

IMPORTANT

- I All vehicle doors must be closed and locked prior to remote start sequence. Failure to comply will result in remote starter malfunction.

TAKE OVER PROCEDURE - PTS - TO THE VEHICLE OWNER

NOTE

- I All vehicle doors must be closed and locked prior to remote start sequence.



TIME RESTRICTION COMING UP !

1



Unlock vehicle door using OEM or after-market remote, or door request switch.

2

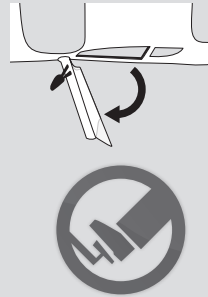

TIME RESTRICTION

Within 45 SECONDS from previous step:

Open vehicle door.
Enter vehicle.
Close vehicle door.

Press and release BRAKE pedal.

3

Take over procedure completed.



Failure to follow procedure will result in vehicle engine shutdown.