

Make	Model	Year	Install	CAN	Lights	IGN	RAP	I/O Changes
DL-CH12 RAM	2500 Diesel PTS	2019-20	Type 4	CJB	Park / Auto Type B	PINK	NO	Green White/Blue N/A

FIRMWARE:

Esta instalación requiere BLADE-AL (DL) -CH12, módulo flash y actualización del firmware del controlador antes de la instalación.

INSTALACIÓN:

Los vehículos de tipo 4 utilizan el cable de extensión CAN incluido para obtener datos CAN del bloque de conexiones CAN verde, ubicado detrás del interruptor del faro.

LUCES:

Las luces de estacionamiento tipo B usan la disposición MUX de 10 pines del arnés, los conectores de 6 pines del arnés no se usan. Asegúrese de que esté debidamente asegurado por seguridad.

ENCENDIDO:

El encendido Tipo 4 está disponible en el conector del módulo del remolque (TMC), ubicado a la derecha de la columna de dirección en el conector gris de 10 pines (pin # 10, rosa / verde).

FTI-CDP1 - Notas de instalación y configuración

- A** CONFIGURACIÓN REQUERIDA (ROSA)
- B** CONEXIÓN REQUERIDA (cable de extensión CAN)
- C** NO REQUERIDA (OBD CAN)
- D** CONEXIÓN REQUERIDA (IGN)



COBERTURA DE FUNCIONES																				
IMMOBILIZER DATA	ARM OEM ALARM	DISARM OEM ALARM	DOOR LOCK	DOOR UNLOCK	PRIORITY UNLOCK	TRUNK/HATCH RELEASE	POWER LIFTGATE	POWER SLIDING DOOR (L)	POWER SLIDING DOOR (R)	SECURE TAKEOVER	DOOR STATUS	TRUNK STATUS	HOOD STATUS	E-BRAKE STATUS	TACH OUTPUT	BRAKE STATUS	GLOW PLUG STATUS	PARKING LIGHTS	HAZARD LIGHTS	A/M CONTROL

•FT-DAS Required for manual transmission.
•BOTH Red & Red/White MUST be connected with high current application.

Jumper Setting

CM7000/7200 **Cut loop for A/T**

CM-900S/900AS

CM900AS/900S Jumper

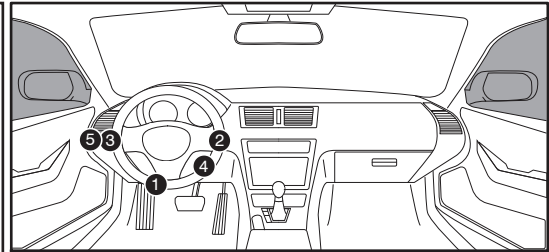
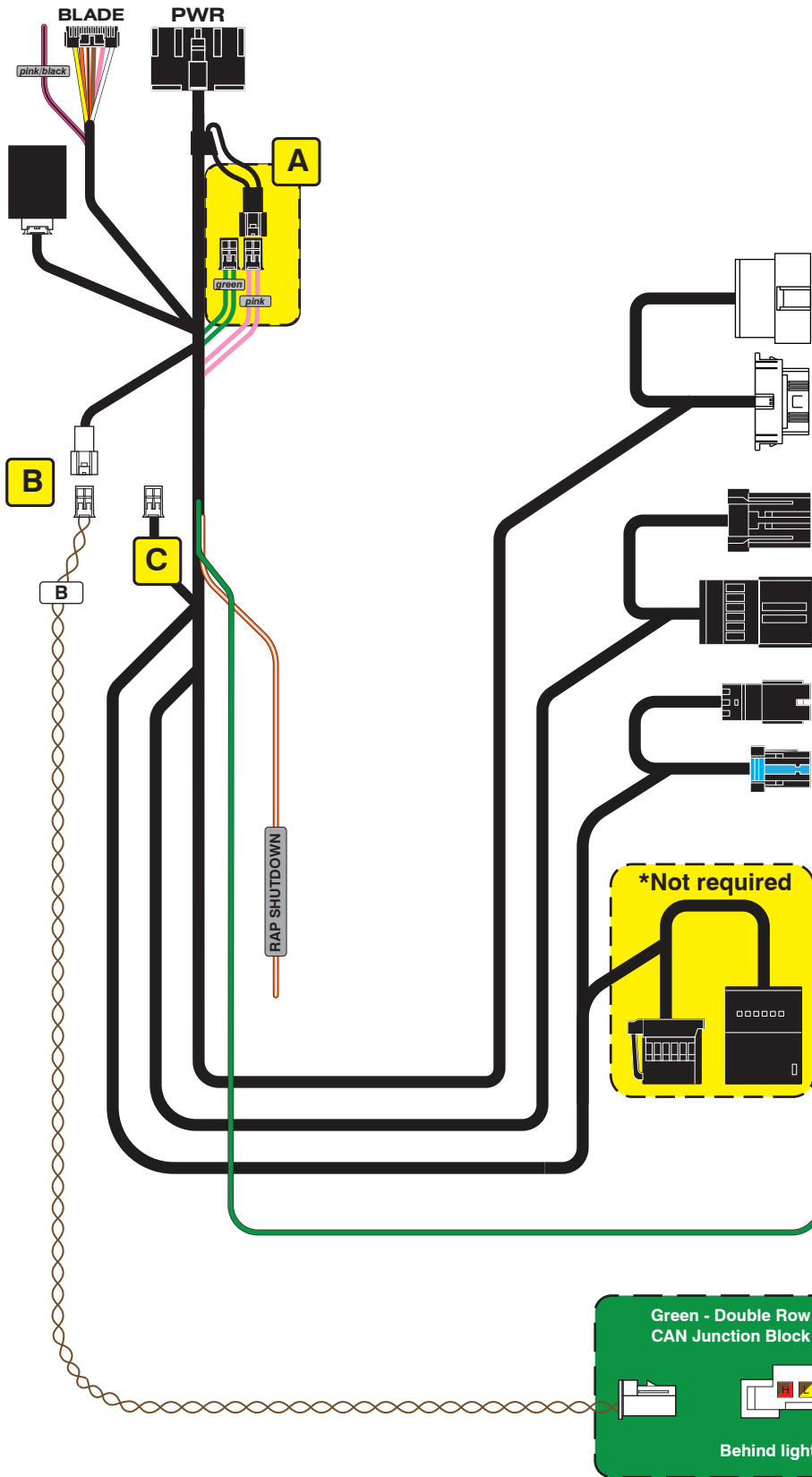

OBD-II connector

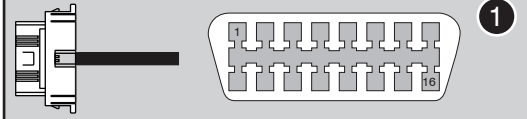

PTS Button



Headlight switch

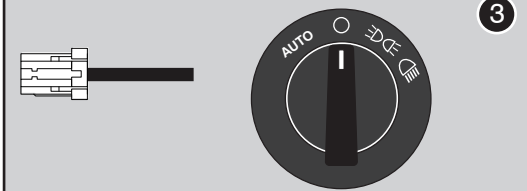

Trailer Module Connector

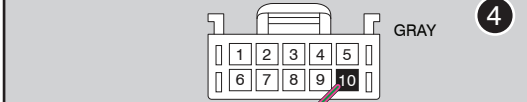

pink/green

CAN Junction Block (behind light switch)

Green CAN-C Junction Block

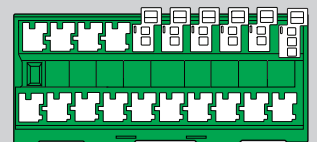

Green - Double Row
CAN Junction Block

Behind light switch

Códigos de error de programación de LED

El LED del módulo parpadea en ROJO durante la programación

- 1x - Error de CAN
- 2x - Código clave no aprendido
- 3x - Sin ENCENDIDO
- 4x - Sin inmovilizador, comprobar CAN / llave
- 5x - Error de VIN, verifique el cableado CAN
- 6x - Ver error 4x
- 7x - Error de KLON
- 8x - Sin ENCENDIDO, verifique la conexión

MODULE PROGRAMMING PROCEDURE - PTS

NOTE

I **IMPORTANT:** The hood must be closed.

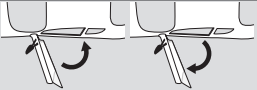
1  Close driver door.
Re-open driver door to wake up data bus.

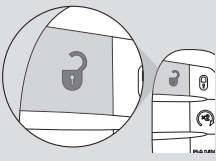
2  Press UNLOCK on OEM remote.

(If the vehicle is not equipped with an OEM remote, press on the module programming button.)

3  Wait, LED will flash BLUE once [1x]. If LED does not flash GREEN, repeat step 2.

4  Set ignition to ON position.

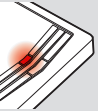

5  Wait, if LED turns solid RED proceed to step 6.
If LED flashes BLUE rapidly, proceed to step 10.

6  Set ignition to OFF position.



7  Repeat steps 4 to 6, eight times [8x].

8  Set ignition to ON position.

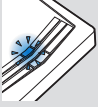

9  Wait, LED will flash BLUE rapidly.

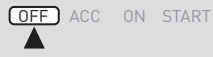
10  Set ignition to OFF position.

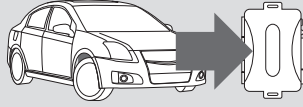

11  **WARNING:**
Disconnect power last.
Disconnect module from vehicle.

12  Connect module to computer and proceed with extended programming.

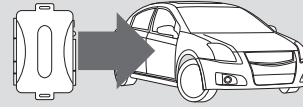
13  **WARNING:** Do not press module programming button.
Connect power first.
Connect module to vehicle.

14  Set ignition to ON position.

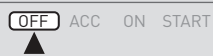

15  Wait, LED will turn solid BLUE for 2 seconds.

16  Set ignition to OFF position.



17 **Module Programming Procedure completed.**

WARNING: READ BEFORE REMOTE STARTING THE VEHICLE

IMPORTANT

- I All vehicle doors must be closed and locked prior to remote start sequence. Failure to comply will result in remote starter malfunction.

TAKE OVER PROCEDURE - PTS - TO THE VEHICLE OWNER

NOTE

- I All vehicle doors must be closed and locked prior to remote start sequence.



TIME RESTRICTION COMING UP !

1



Unlock vehicle door using OEM or after-market remote, or door request switch.

2

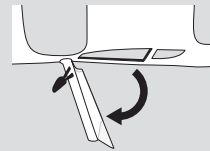

TIME RESTRICTION

Within 45 SECONDS from previous step:

Open vehicle door.
Enter vehicle.
Close vehicle door.

Press and release BRAKE pedal.

3

Take over procedure completed.



Failure to follow procedure will result in vehicle engine shutdown.