

Overview: Mis-Wired door lock connector, field repair required.

Issue: A review of the latest samples of **FTI-TLP4 T-harnesses** has revealed a misplaced trunk output wire in the 6-pin Lock Accessory Connector requiring that the wire be relocated to the correct position, to ensure safe operation when used. **Using the harness without addressing the issue will result in failed trunk/hatch control, and possible damage to the vehicle BCM.**

Correction: The harness purple/white wire in the latest production run of FTI-TLP4 harnesses has been inserted in the position normally used for the +12V power connection in the accessory harness. Before completing the installation, the installer must relocate the harness purple/white wire to the correct position, 1 space inward on the 6-pin connector, see illustrations below in Fig. 2.

To relocate the terminal, using a fine pick or Olfa type knife, depress the terminal locking barb and pull the purple/white wire from the connector housing. Once the terminal has been removed from the housing, again using the pick or knife, lift the locking barb about 1/16" (1.5 mm) and reinsert the terminal in the correct position. If upon initial examination of the harness the lock accessory connector looks like the illustration in Fig. 2, no modification is necessary, the wire is in the proper position.

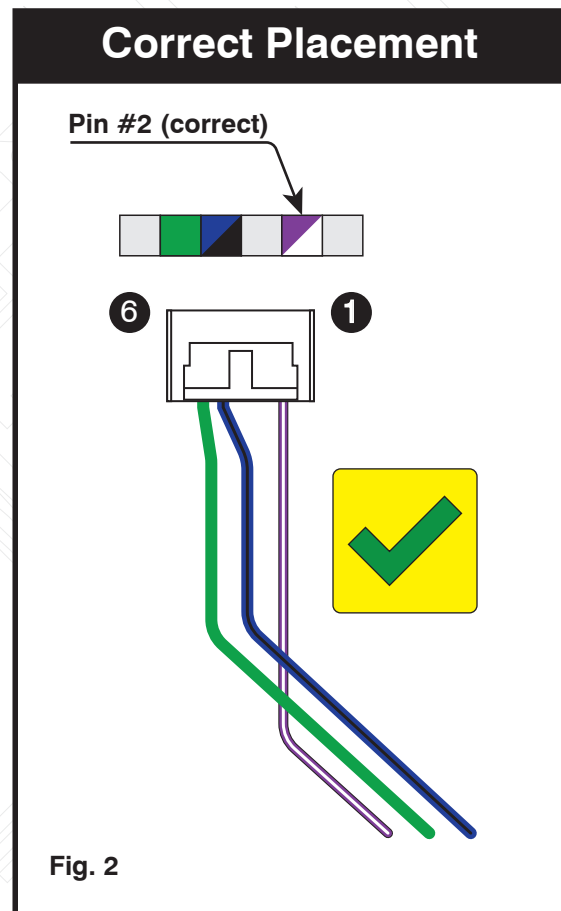
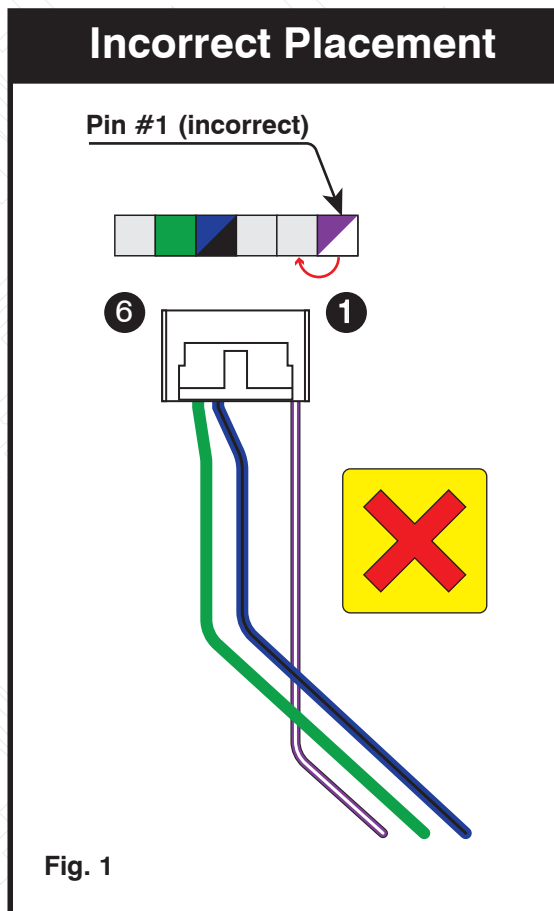

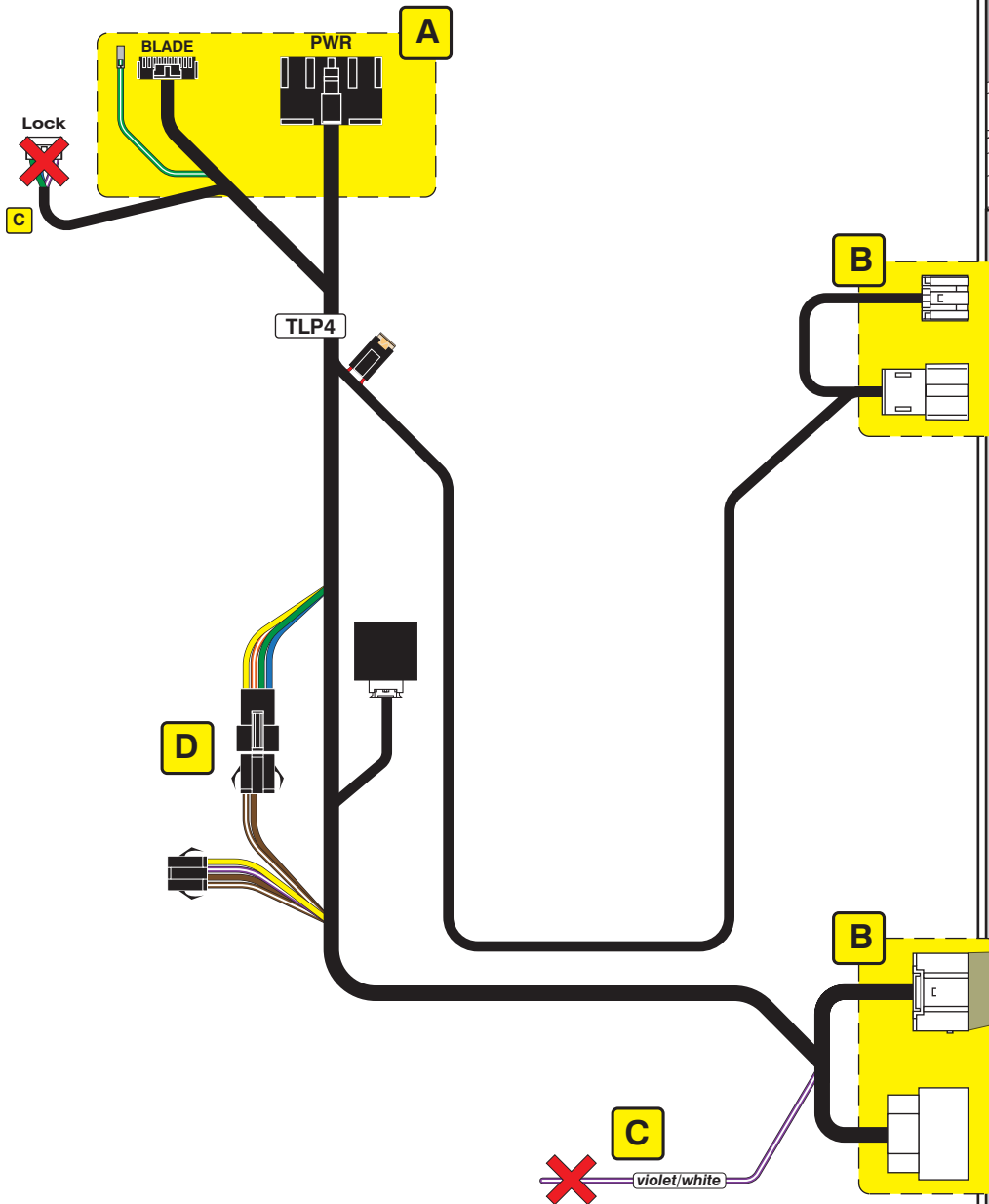

Steering Lock Connector



Main Body ECU

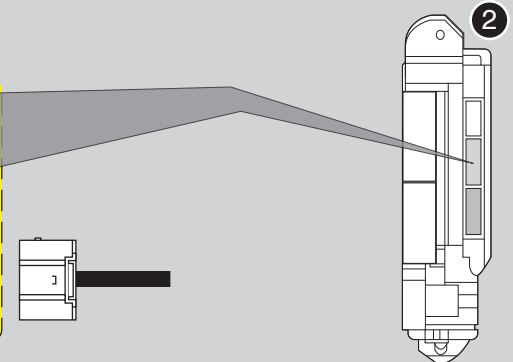

LED Programming Error Codes

- Module LED flashing RED during programming
- 1x - No CAN detected, check connections
 - 2x - VIN not read, check connections
 - 3x - VIN unknown, force platform
 - 4x - No IMMO
 - 5x - OEM remote starter detected, remove
 - 6x - Key platform detected, check connections
 - 7x - No RX detected, check connections
 - 8x - No TX detected, check connections

TAKEOVER NOT SUPPORTED: THE VEHICLE WILL SHUT DOWN UPON OPENING DRIVER'S DOOR

CARTRIDGE INSTALLATION

1

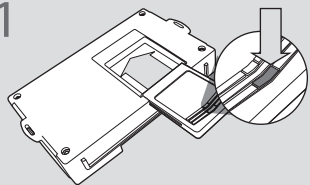

Slide cartridge into unit. Notice button under LED.

2

Ready for Module Programming Procedure.

MODULE PROGRAMMING PROCEDURE

NOTE

I Between each step, LED will turn solid RED, this is the default standby mode.

1



Push start button twice [2x] to ON position.

2

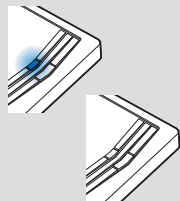

Wait, LED will turn solid BLUE then will turn OFF.

3

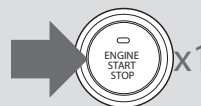

Push start button once [1x] to OFF position.

4

Module Programming Procedure completed.