

Overview: Production error in version 1.0 harnesses; The immobilizer wire (orange/black) is in pin position #4 instead of pin position #5. Although an effort to correct the issue was made, some quantity of harnesses did get shipped before the issue was spotted. We are advising to inspect the harness BLADE connector before attempting to install harness or program the module. This issue is not known to affect the version 2 harnesses, which require no modification.

Issue: Module fails to program correctly to vehicle, does not allow the vehicle to be remote started.

Correction: Step 1.) Locate the orange/black wire and confirm whether it is positioned as illustrated in Fig. 1 or Fig. 2. If the wire is as illustrated in Fig.1, proceed with Step 2 through 5 and complete the repair procedure outlined, if the wire is as illustrated in Fig. 2, correction is not necessary, proceed with harness installation and module programming.

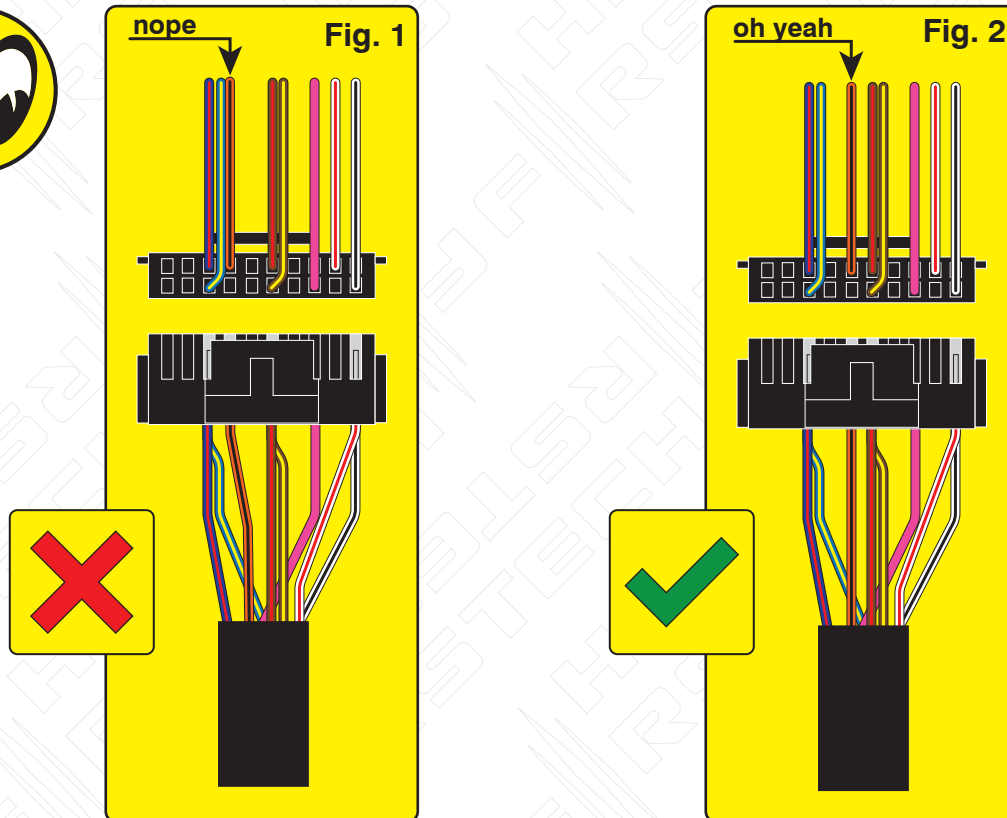

Step 2.) Using a pick, lightly depress the catch that secures the terminal in the housing then remove the wire and terminal from the housing.

Step 3.) Using a fine tip razor or utility knife, insert the blade beneath the terminal catch and raise it slightly, so that it can be reused to secure the terminal when reinserted into the BLADE connector housing.

Step 4.) Refer to Fig. 2 for correct position of the orange/black wire (next to brown/red) then reinsert the terminal, pressing lightly until the catch 'snaps' into place, securing the terminal in the connector housing.

Step 5.) The repair is complete, proceed with installation and programming.



Descripción general: Las primeras versiones del arnés FTI-STP1 requieren modificaciones para aplicaciones de transmisión automática (AT), algunas del producto se pudo modificar antes del lanzamiento, pero una pequeña cantidad se lanzó sin modificaciones.

Problema: El arnés en T FTI-STP1 ha sido diseñado para ser compatible con A/T (transmisión automática) y M/T (manual), pero debido a un descuido en las primeras ejecuciones de producción, la selección se estableció por defecto en el modo M/T.

El uso de un arnés configurado para una aplicación M/T, en un vehículo equipado con A/T, podría provocar daños en el módulo del vehículo, se recomienda que el arnés vuelva al modo A/T antes de la instalación en vehículos equipados con transmisión automática.

Corrección: Localice el cable rojo/negro (+ embrague) proporcionado en el conector CN1 del conjunto del arnés principal. Corte el cable rojo/negro, ya sea al ras del conector CN1 o dejando suficiente cable expuesto para que pueda aislar y asegure los extremos del cable que quedan después del corte. Aísle cada uno de los extremos restantes del cable rojo/negro y asegúrelos para evitar cualquier posibilidad de cortocircuito. Si el cable rojo/negro ya ha sido desconectado, ninguna modificación adicional se requiere para aplicaciones A/T

MODIFICACIÓN REQUERIDA PARA APLICACIONES A/T, SÓLO CON ARNÉS v 1.0

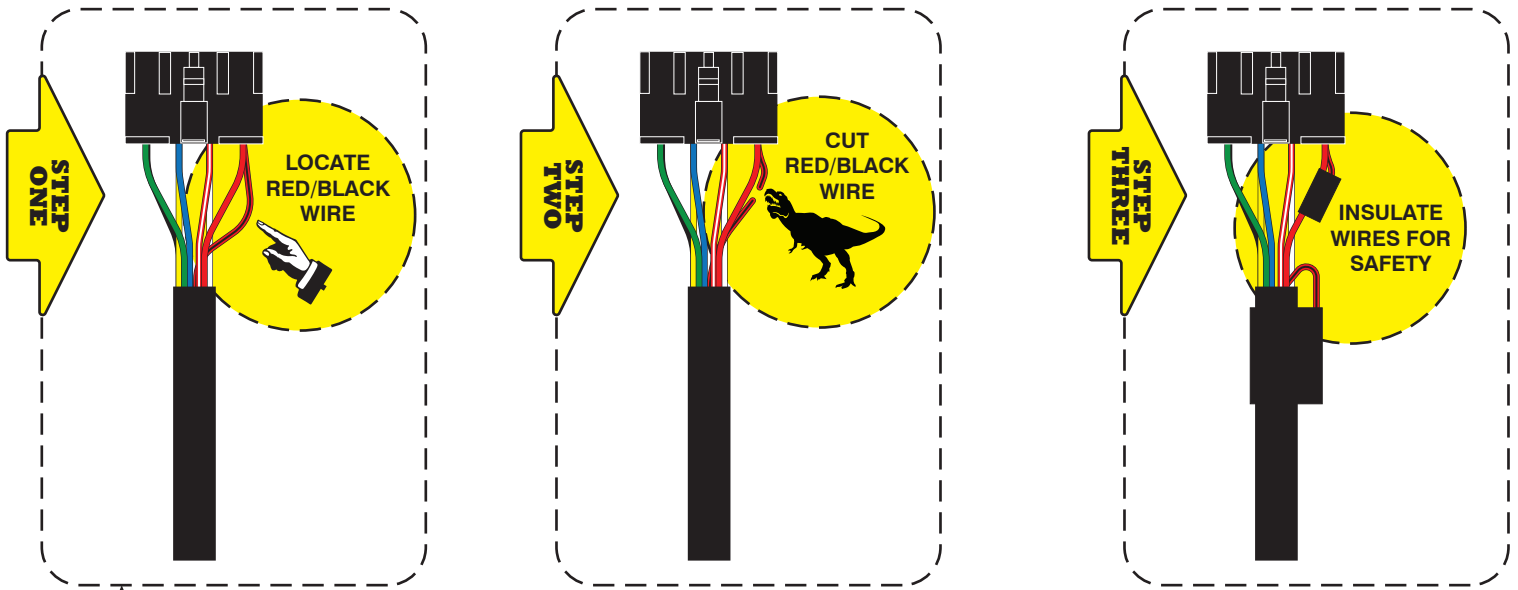

NO SE REQUIERE MODIFICACIÓN CUANDO SE UTILIZA FTI-STP1 (v 1.0) ARNÉS EN APLICACIONES M/T, O CUANDO UTILICE EL ARNÉS FTI-STP1 (v 2.0)

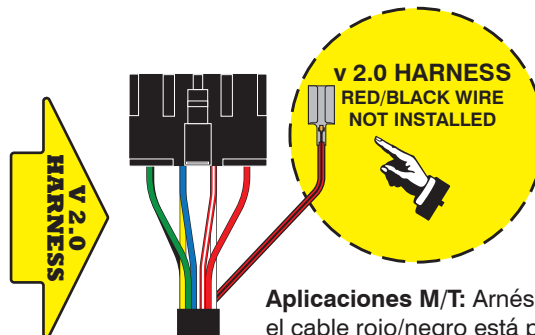
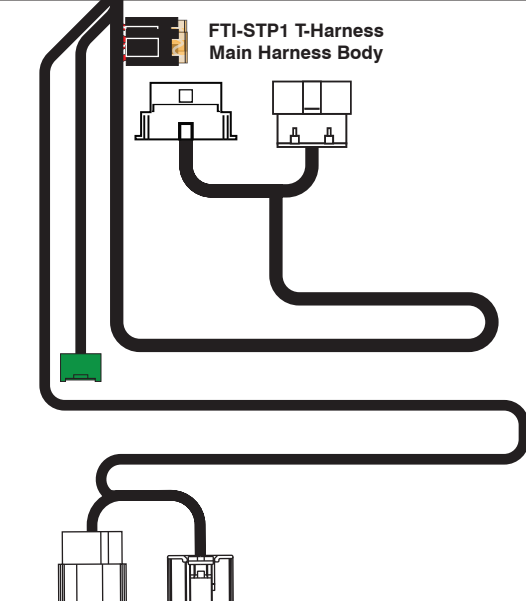

Aplicaciones M/T: Arnés versión 2.0, el cable rojo/negro está pegado al arnés principal cuando se envía, y debe instalarse en el CN1 conector cuando está instalado.

Aplicaciones A/T: Deje el cable rojo/negro pegado al arnés, no es necesario para aplicaciones A/T



FTI-STP1: Notas de preparación y cobertura del vehículo

Make	Model	Year	Install	CECU/KAECU	Lights	ECU	POC	I/O Changes
DL-SUB2 Scion	FR-S PTS MT	2013-16	Type 1	BGB	Park / Auto DATA	BGB	N/A	Green White/Blue START2/NONE

Esta instalación requiere el firmware **BLADE-AL (DL) -SUB2**, el módulo flash y la actualización del firmware del controlador antes de la instalación.

Luces de estacionamiento / diagnóstico: el control de las luces de diagnóstico y de estado se proporciona a través de datos, no se requieren conexiones adicionales.

Instalación de tipo 1: se requiere el **adaptador A** (conectores de 30 y 18 clavijas) para este tipo de instalación. *No se requiere el adaptador B (30 y 28 pines).*

Ubicaciones de ECU / conector de empalme:

BFB: Detrás de la caja de fusibles

BGB: Detrás de la guantera

BIC: Detrás del grupo de instrumentos

PSUH: lado del pasajero debajo del capó

Cambios de E / S de la aplicación de transmisión manual:

Controladores de las series CMX y CM7: Configure la salida de luz de estacionamiento CN1 para la salida **START2**.

CM7: Mueva el puente 3 a la posición START.

CMX: Configure la salida **HCP 1** para el **2nd START** (S- # 4-1-2)

Los controladores de la serie CM9 no son compatibles con aplicaciones de transmisión manual.

NO INTENTE ESTA COMBINACIÓN. □

FTI-STP1: Notas de instalación y configuración

- A** ADAPTADOR A - REQUERIDO
- B** ADAPTADOR B - NO UTILIZAR
- C** SE REQUIERE ATENCIÓN ESPECIAL

•FT-DAS Required for manual transmission.
•BOTH Red & Red/White MUST be connected with high current application.

Jumper Setting

Parking Light	Accessory	Ignition (Default)	Trunk	Starter	Parking Light (Default)	(+)-Door Trigger In (Default)	(-)-Door Trigger In (Default)	Starter Ignition	Accessory (Default)
---------------	-----------	--------------------	-------	---------	-------------------------	-------------------------------	-------------------------------	------------------	---------------------

CM7000/7200 Cut loop for A/T



COBERTURA DE FUNCIONES	
IMMOBILIZER DATA	○
ARM OEM ALARM	○
DISARM OEM ALARM	○
DOOR LOCK	○
DOOR UNLOCK	○
TRUNK/HATCH RELEASE	○
A/M CONTROL FROM OEM REMOTES	○
A/M CONTROL FROM DOOR HANDLE	○
BRAKE STATUS	○
E-BRAKE STATUS	○
DOOR STATUS	○
TRUNK STATUS	○
P/N SWITCH STATUS	○
VSS STATUS	○
TACH OUTPUT	○
SECURE TAKEOVER	○
AUTO TAKEOVER	○
RAP SHUTDOWN	○
A/M REMOTE START FROM OEM REMOTE	○
PARKING LIGHTS	○
POWER LIFTGATE	○
DISCO BALL	○

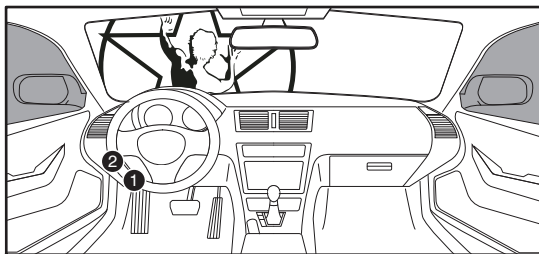
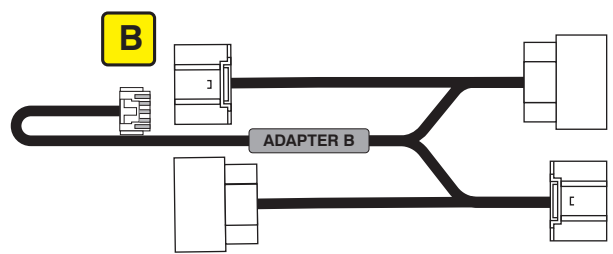
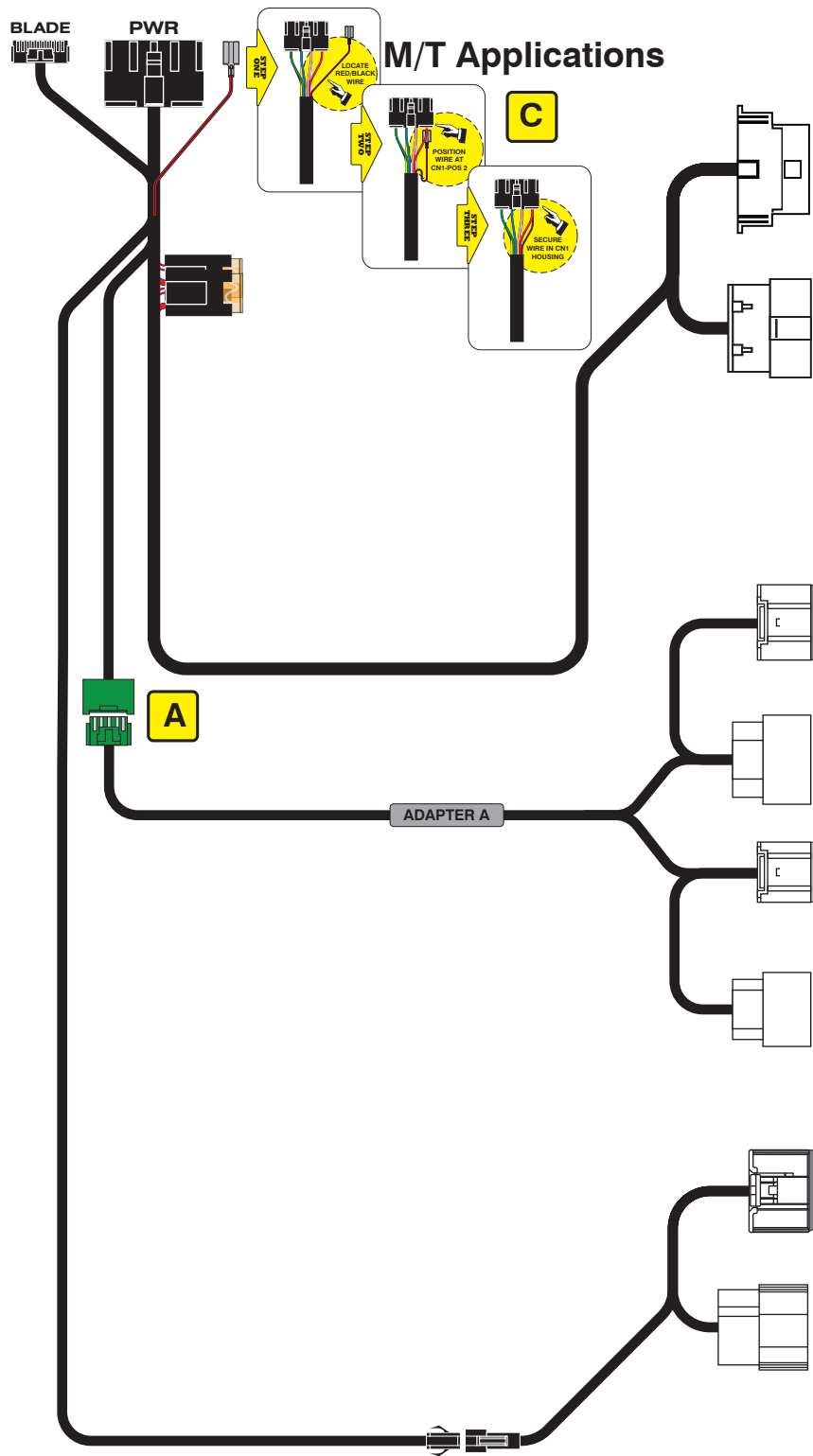

OBD-II Connector

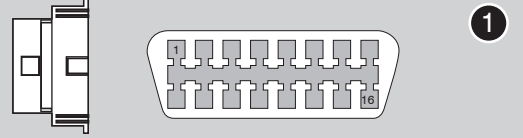

Certification ECU

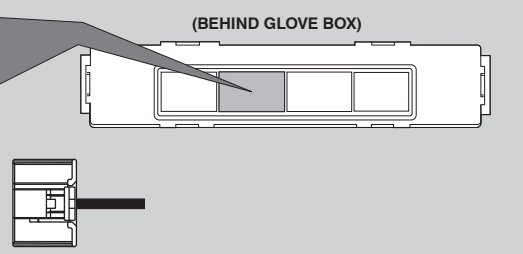
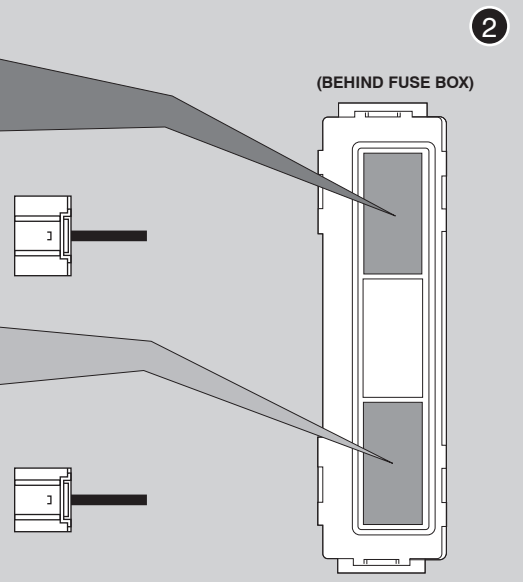

Códigos de error de programación de LED

- El LED del módulo parpadea en ROJO durante la programación
- 1x - No hay datos IMMO, arranca el coche, comprueba el cableado
 - 3x - arrancador remoto OEM detectado (eliminar)
 - 4x - No hay encendido, arranca el coche, comprueba el cableado
 - 6x - Problema de IMMO, arranca el coche, comprueba la CAN
 - 7x - Problema de IMMO, arranca el coche, comprueba la CAN

CARTRIDGE INSTALLATION

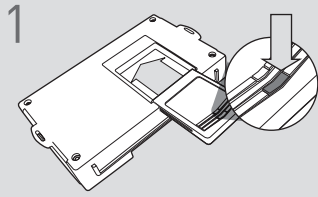

1 Slide cartridge into unit. Notice button under LED.

2

Ready for Module Programming Procedure.

MODULE PROGRAMMING PROCEDURE

NOTE

- 1 When programming, only one keyfob will be used. The other one must be located at least 10 feet away from the vehicle.



1 Push start button twice [2x] to ON position.

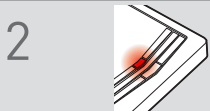

2 LED will turn solid RED.



3 Start engine.

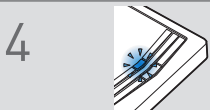

4 Wait, LED will flash BLUE rapidly.



5 Push start button once [1x] to OFF position.

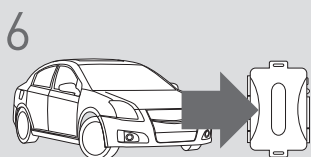

6 **WARNING:**
Disconnect power last.
Disconnect RS from vehicle.

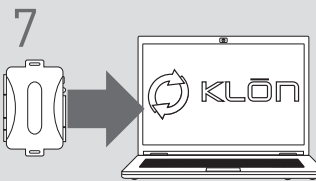

7 Connect RS to computer and proceed with extended programming.

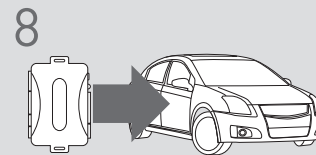

8 **WARNING:**
Connect power first.
Connect RS to vehicle.



9 Push start button twice [2x] to ON position.

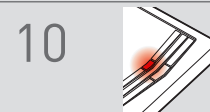

10 LED will turn solid RED.



11 Start engine.



12 Wait, LED will turn solid BLUE.



13 Push start button once [1x] to OFF position.

14

Module Programming Procedure completed.

WARNING: READ BEFORE REMOTE STARTING THE VEHICLE

IMPORTANT

- I All vehicle doors must be closed and locked prior to remote start sequence. Failure to comply will result in remote starter malfunction.

TAKE OVER PROCEDURE - TO THE VEHICLE OWNER

NOTE

- I All vehicle doors must be closed and locked prior to remote start sequence.



TIME RESTRICTION COMING UP !

1



Press UNLOCK on after-market remote.

2

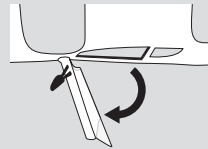

TIME RESTRICTION

Within 45 SECONDS from previous step:

Have a valid key on you.
Open vehicle door.
Enter vehicle.
Close vehicle door.

Wait approximately 3 seconds for the automated takeover, then press and release BRAKE pedal.

3

Take over procedure completed.



Failure to follow this procedure will result in a vehicle engine shutdown.