

Overview: Production error in version 1.0 harnesses; The immobilizer wire (orange/black) is in pin position #4 instead of pin position #5. Although an effort to correct the issue was made, some quantity of harnesses did get shipped before the issue was spotted. We are advising to inspect the harness BLADE connector before attempting to install harness or program the module. This issue is not known to affect the version 2 harnesses, which require no modification.

Issue: Module fails to program correctly to vehicle, does not allow the vehicle to be remote started.

Correction: Step 1.) Locate the orange/black wire and confirm whether it is positioned as illustrated in Fig. 1 or Fig. 2. If the wire is as illustrated in Fig.1, proceed with Step 2 through 5 and complete the repair procedure outlined, if the wire is as illustrated in Fig. 2, correction is not necessary, proceed with harness installation and module programming.

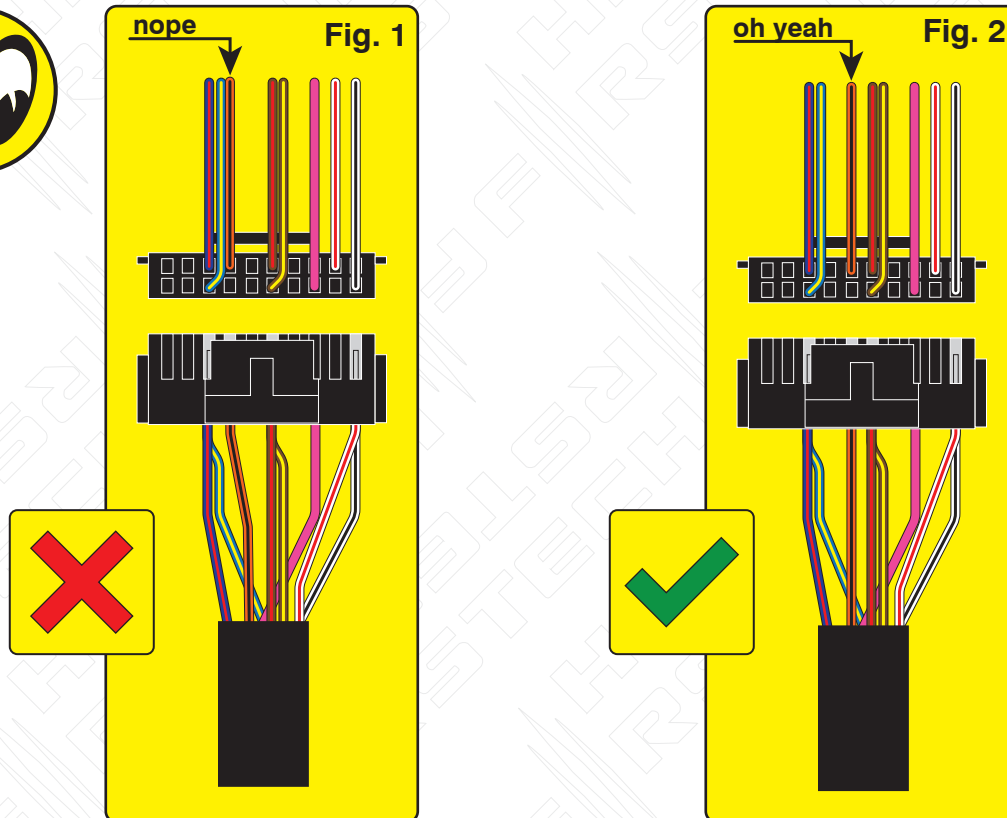

Step 2.) Using a pick, lightly depress the catch that secures the terminal in the housing then remove the wire and terminal from the housing.

Step 3.) Using a fine tip razor or utility knife, insert the blade beneath the terminal catch and raise it slightly, so that it can be reused to secure the terminal when reinserted into the BLADE connector housing.

Step 4.) Refer to Fig. 2 for correct position of the orange/black wire (next to brown/red) then reinsert the terminal, pressing lightly until the catch 'snaps' into place, securing the terminal in the connector housing.

Step 5.) The repair is complete, proceed with installation and programming.



Overview: Early versions of the FTI-STP1 harness require modification for **automatic transmission (AT)** applications, some of the product was able to be modified before release, but a small quantity was released without modification.

Issue: The FTI-STP1 T-harness has been designed to be compatible with A/T (automatic transmission) & M/T (manual transmission) applications, but due to an oversight in early production runs, the selection was defaulted to M/T mode.

Using a harness configured for an M/T application, in an A/T equipped vehicle, could result in vehicle module damage, it is advised that the harness be returned to A/T mode before installation in vehicles equipped with an automatic transmission.

Correction: Locate the **red/black (+ Clutch)** wire provided in the CN1 connector of the main harness assembly. Cut the **red/black** wire, either flush to the CN1 connector, or leaving enough wire exposed so that you can insulate and secure the ends of the wire that remain after cutting. Insulate each of the remaining ends of the **red/black** wire and secure to prevent any possibility of a short circuit. **If the red/black wire has already been disconnected, no further modification is required for A/T applications**

MODIFICATION REQUIRED FOR A/T APPLICATIONS, ONLY WITH v 1.0 HARNESS

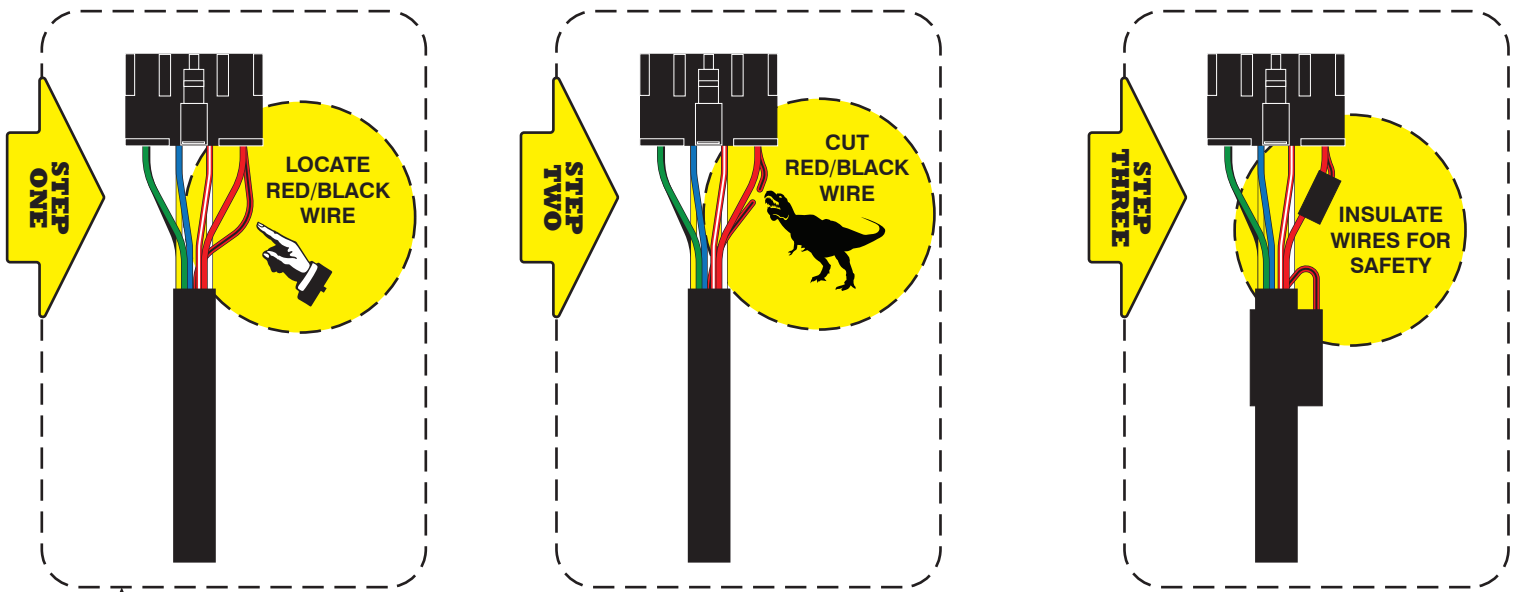

MODIFICATION NOT REQUIRED WHEN USING FTI-STP1 (v 1.0) HARNESS IN M/T APPLICATIONS, OR WHEN USING THE FTI-STP1 (v 2.0) HARNESS

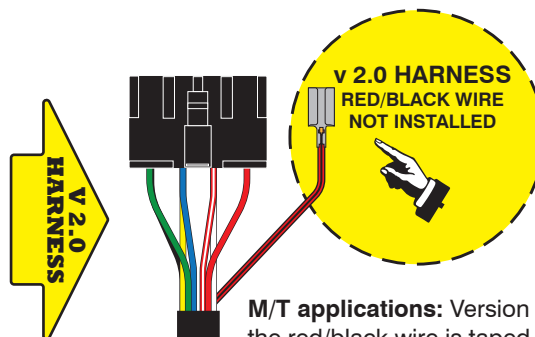
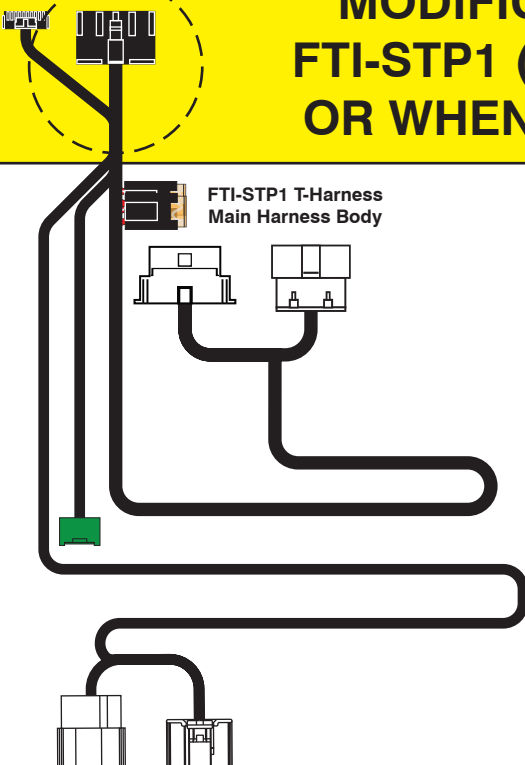

M/T applications: Version 2.0 harness, the red/black wire is taped to the main harness when shipped, and must be installed in the CN1 connector when installed.

A/T applications: Leave the red/black wire taped to the harness, it is not required for A/T applications



FTI-STP1: Vehicle Coverage and Preparation Notes

Make	Model	Year	Install	CECU/KAECU	Lights	ECU	POC	I/O Changes
DL-SUB2 Scion	FR-S PTS MT	2013-16	Type 1	BGB	Park / Auto DATA	BGB	N/A	Green White/Blue START2/NONE

This installation requires **BLADE-AL(DL)-SUB2** firmware, flash module and update the controller firmware before installation.

Parking/Diagnostic Lights: Status and diagnostic light control is provided via data, no additional connections required.

Type 1 Install: Adapter A (30-pin & 18-pin connectors) is required for this install type. *Adapter B (30-pin & 28-pin) is not required.*

ECU/Junction Connector Locations:

- BFB:** Behind Fuse Box
- BGB:** Behind Glove Box
- BIC:** Behind Instrument Cluster
- PSUH:** Passenger Side Under Hood

Manual Transmission Application I/O Changes:

- CMX and CM7 Series controllers:** Configure CN1 parking light output for START2 output.
- CM7:** Move Jumper 3 to START position.
- CMX:** Configure HCP 1 output for 2nd START (S-#4-1-2)
- CM9 Series controllers are not compatible with manual transmission applications. DO NOT ATTEMPT THIS COMBINATION.**



FTI-STP1: Installation and Configuration Notes

- A** ADAPTER A - REQUIRED
- B** ADAPTER B - DO NOT USE
- C** SPECIAL ATTENTION REQUIRED

•FT-DAS Required for manual transmission.
•BOTH Red & Red/White MUST be connected with high current application.

Jumper Setting

CM7000/7200 Cut loop for A/T



FEATURE COVERAGE	
IMMOBILIZER DATA	○
ARM OEM ALARM	○
DISARM OEM ALARM	○
DOOR LOCK	○
DOOR UNLOCK	○
TRUNK/HATCH RELEASE	○
A/M CONTROL FROM OEM REMOTES	○
A/M CONTROL FROM DOOR HANDLE	○
BRAKE STATUS	○
E-BRAKE STATUS	○
DOOR STATUS	○
TRUNK STATUS	○
P/N SWITCH STATUS	○
VSS STATUS	○
TACH OUTPUT	○
SECURE TAKEOVER	○
AUTO TAKEOVER	○
RAP SHUTDOWN	○
A/M REMOTE START FROM OEM REMOTE	○
PARKING LIGHTS	○
POWER LIFTGATE	○
DISCO BALL	○

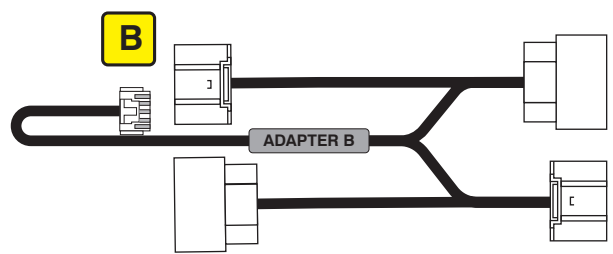
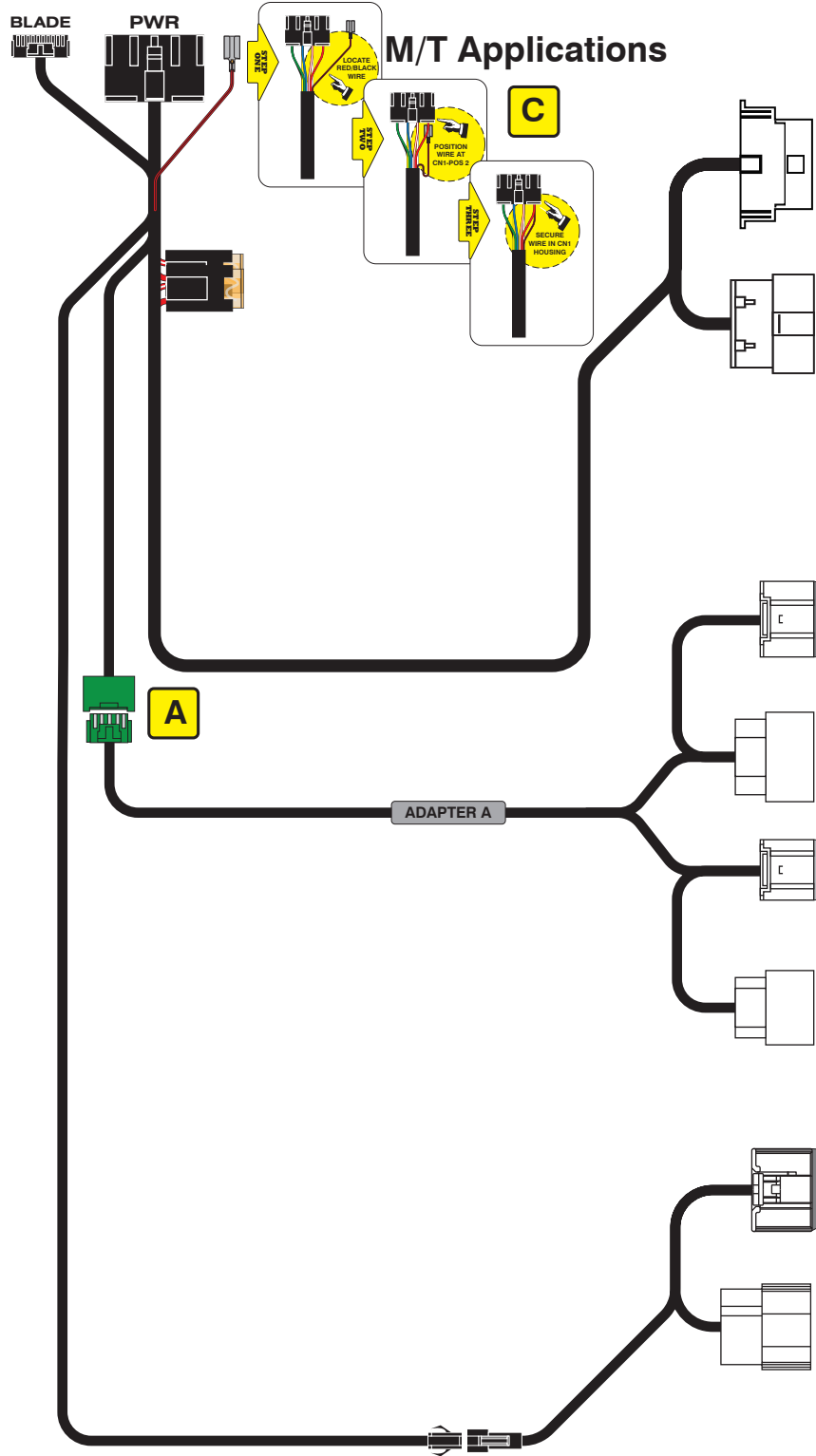

OBD-II Connector

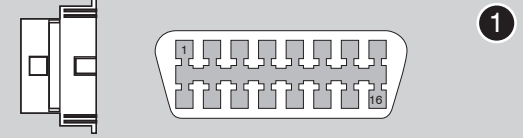

Certification ECU

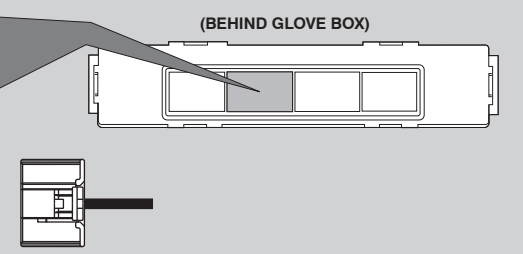
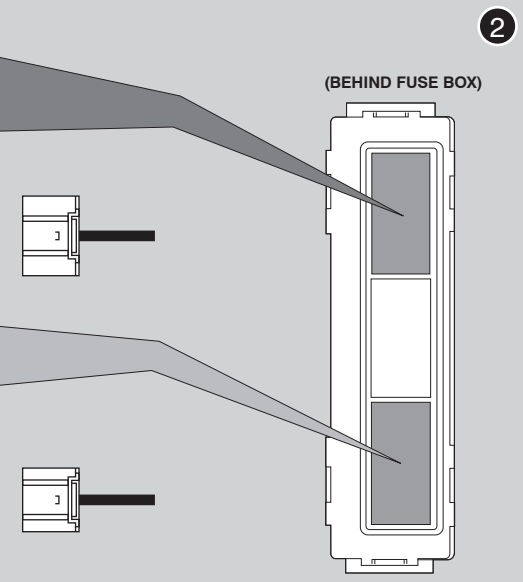

LED Programming Error Codes

- Module LED flashing RED during programming
- 1x - No IMMO data, start car, check wiring
 - 3x - OEM remote starter detected (remove)
 - 4x - No Ignition, start car, check wiring
 - 6x - IMMO problem, start car, check CAN
 - 7x - IMMO problem, start car, check CAN

CARTRIDGE INSTALLATION

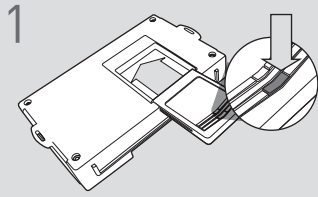

1 Slide cartridge into unit. Notice button under LED.

2

Ready for Module Programming Procedure.

MODULE PROGRAMMING PROCEDURE

NOTE

- 1 When programming, only one keyfob will be used. The other one must be located at least 10 feet away from the vehicle.



1 Push start button twice [2x] to ON position.

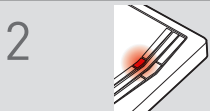

2 LED will turn solid RED.



3 Start engine.



4 Wait, LED will flash BLUE rapidly.



5 Push start button once [1x] to OFF position.

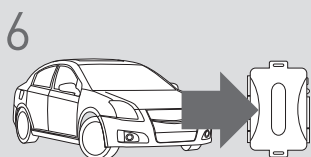

6 **WARNING:**
Disconnect power last.
Disconnect RS from vehicle.

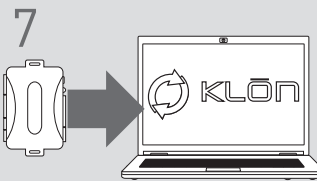

7 Connect RS to computer and proceed with extended programming.

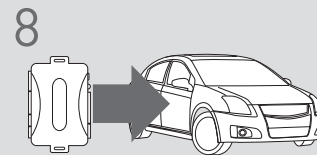

8 **WARNING:**
Connect power first.
Connect RS to vehicle.



9 Push start button twice [2x] to ON position.

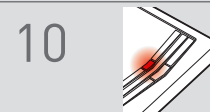

10 LED will turn solid RED.



11 Start engine.



12 Wait, LED will turn solid BLUE.



13 Push start button once [1x] to OFF position.

14

Module Programming Procedure completed.

WARNING: READ BEFORE REMOTE STARTING THE VEHICLE

IMPORTANT

- I All vehicle doors must be closed and locked prior to remote start sequence. Failure to comply will result in remote starter malfunction.

TAKE OVER PROCEDURE - TO THE VEHICLE OWNER

NOTE

- I All vehicle doors must be closed and locked prior to remote start sequence.



TIME RESTRICTION COMING UP !

1



Press UNLOCK on after-market remote.

2

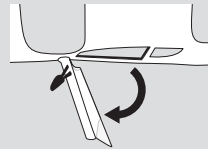

TIME RESTRICTION

Within 45 SECONDS from previous step:

Have a valid key on you.
Open vehicle door.
Enter vehicle.
Close vehicle door.

Wait approximately 3 seconds for the automated takeover, then press and release BRAKE pedal.

3

Take over procedure completed.



Failure to follow this procedure will result in a vehicle engine shutdown.