

Overview: Production error; immobilizer wire (orange/black) in pin position #4 instead of pin position #5. Although an effort to correct the issue was made, some quantity of harnesses did get shipped before the issue was spotted. We are advising to inspect the harness BLADE connector before attempting to install the harness and program the module.

Issue: Module fails to program to vehicle, will not allow the vehicle to be remote started.

Correction: Step 1.) Locate the orange/black wire and confirm whether it is positioned as illustrated in Fig. 1 or Fig. 2. If the wire is as illustrated in Fig.1, proceed with Step 2 through 5 and complete the repair procedure outlined, if the wire is as illustrated in Fig. 2, correction is not necessary, proceed with harness installation and module programming.

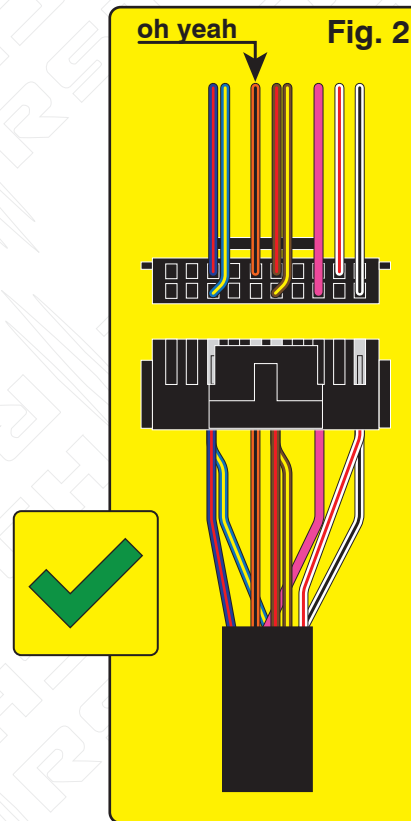
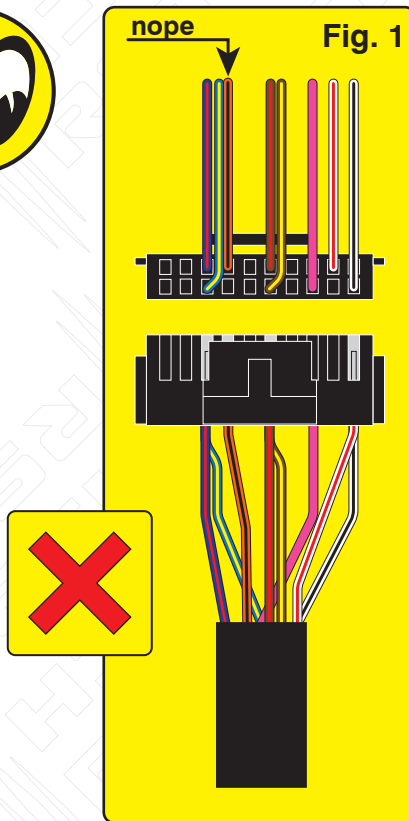

Step 2.) Using a pick, lightly depress the catch that secures the terminal in the housing then remove the wire and terminal from the housing.

Step 3.) Using a fine tip razor or utility knife, insert the blade beneath the terminal catch and raise it slightly, so that it can be reused to secure the terminal when reinserted into the BLADE connector housing.

Step 4.) Refer to Fig. 2 for correct position of the orange/black wire (next to brown/red) then reinsert the terminal, pressing lightly until the catch 'snaps' into place, securing the terminal in the connector housing.

Step 5.) The repair is complete, proceed with installation and programming.



Descripción general: El nuevo arnés en T FTI-STP1 requiere modificaciones para su uso en aplicaciones de transmisión automática (AT).

Problema: El arnés en T FTI-STP1 ha sido diseñado para ser compatible con AT (transmisión automática) y MT (transmisión manual), pero debido a una supervisión de la producción, el mecanismo de selección se estableció por defecto en el modo MT.

El uso de un arnés configurado para una aplicación MT, en un vehículo equipado con AT, podría provocar daños en el módulo del vehículo. Se recomienda que el arnés vuelva al modo AT antes de instalarlo en vehículos equipados con transmisión automática.

Corrección: Localice el cable rojo/negro (+ embrague) provisto en el conector CN1 del conjunto del arnés principal. Corte el cable rojo / negro, ya sea al ras del conector CN1 o dejando suficiente cable expuesto para que pueda aislar y asegure los extremos del alambre que quedan después del corte. Aísle cada uno de los extremos restantes del cable rojo/negro y asegúrelos para evitar cualquier posibilidad de cortocircuito.

MODIFICACIÓN REQUERIDA PARA APLICACIONES DE TRANSMISIÓN AUTOMÁTICA ÚNICAMENTE

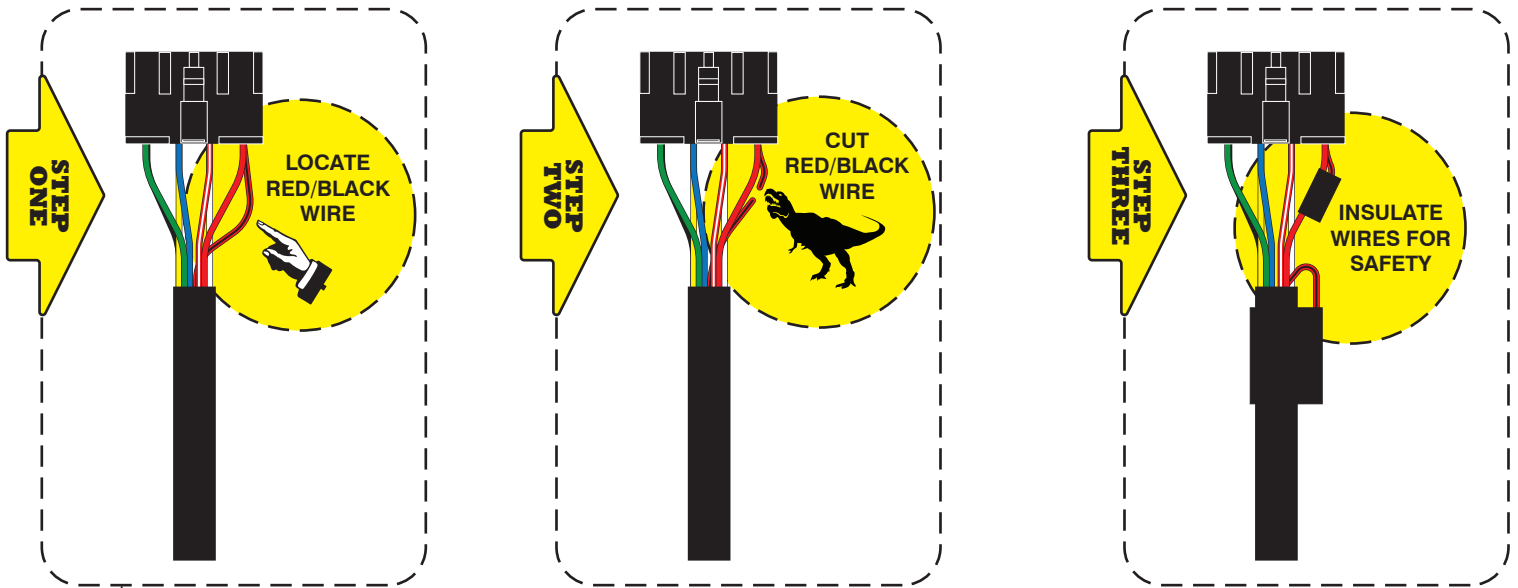

NO SE REQUIERE MODIFICACIÓN AL UTILIZAR ARNÉS FTI-STP1 EN TRANSMISIÓN MANUAL APLICACIONES

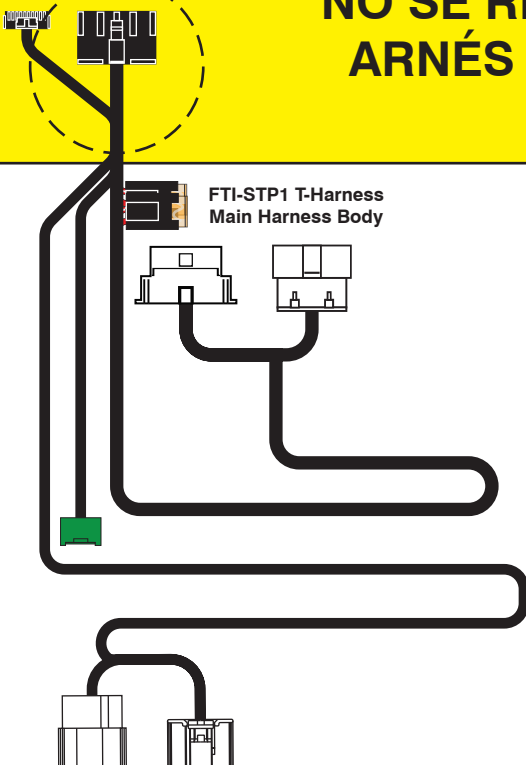

Make	Model	Year	Install	CECU/KAECU	Lights	ECU	POC	I/O Changes
DL-SUB2 Toyota	86 PTS AT	2017-20	Type 1	BGB	Park / Auto DATA	BGB	N/A	Green White/Blue NONE/NONE

Esta instalación requiere el firmware **BLADE-AL (DL) -SUB2**, el módulo flash y la actualización del firmware del controlador antes de la instalación.

Luces de estacionamiento / diagnóstico: el control de las luces de diagnóstico y de estado se proporciona a través de datos, no se requieren conexiones adicionales.

Instalación de tipo 1: se requiere el **adaptador A** (conectores de 30 y 18 clavijas) para este tipo de instalación. *No se requiere el adaptador B (30 y 28 pines).*

Ubicaciones de ECU / conector de empalme:

BFB: Detrás de la caja de fusibles

BGB: Detrás de la guantera

BIC: Detrás del grupo de instrumentos

PSUH: lado del pasajero debajo del capó

Cambios de E / S de la aplicación de transmisión automática:

Controladores de las series CMX, CM7 y CM9: no se requieren cambios de configuración. Consulte la página anterior para conocer las modificaciones necesarias. en la posición de salida de la luz de estacionamiento del conector CN1 (+ embrague).

FTI-STP1: Notas de instalación y configuración

A ADAPTADOR A - REQUERIDO

B ADAPTADOR B - NO UTILIZAR

C SE REQUIERE MODIFICACIÓN PARA LA TRANSMISIÓN AUTOMÁTICA



COBERTURA DE FUNCIONES																					
IMMOBILIZER DATA	ARM OEM ALARM	DISARM OEM ALARM	DOOR LOCK	DOOR UNLOCK	TRUNK/HATCH RELEASE	A/M CONTROL FROM OEM REMOTES	A/M CONTROL FROM DOOR HANDLE	BRAKE STATUS	E-BRAKE STATUS	DOOR STATUS	TRUNK STATUS	P/N SWITCH STATUS	VSS STATUS	TACH OUTPUT	SECURE TAKEOVER	AUTO TAKEOVER	RAP SHUTDOWN	A/M REMOTE START FROM OEM REMOTE	PARKING LIGHTS	POWER LIFTGATE	DISCO BALL

•FT-DAS Required for manual transmission.
•BOTH Red & Red/White MUST be connected with high current application.

Jumper Setting

CM7000/7200 **Cut loop for A/T**

CM-900S/900AS

CM900AS/900S Jumper

AT Applications

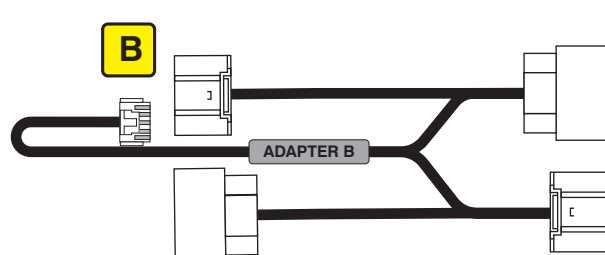
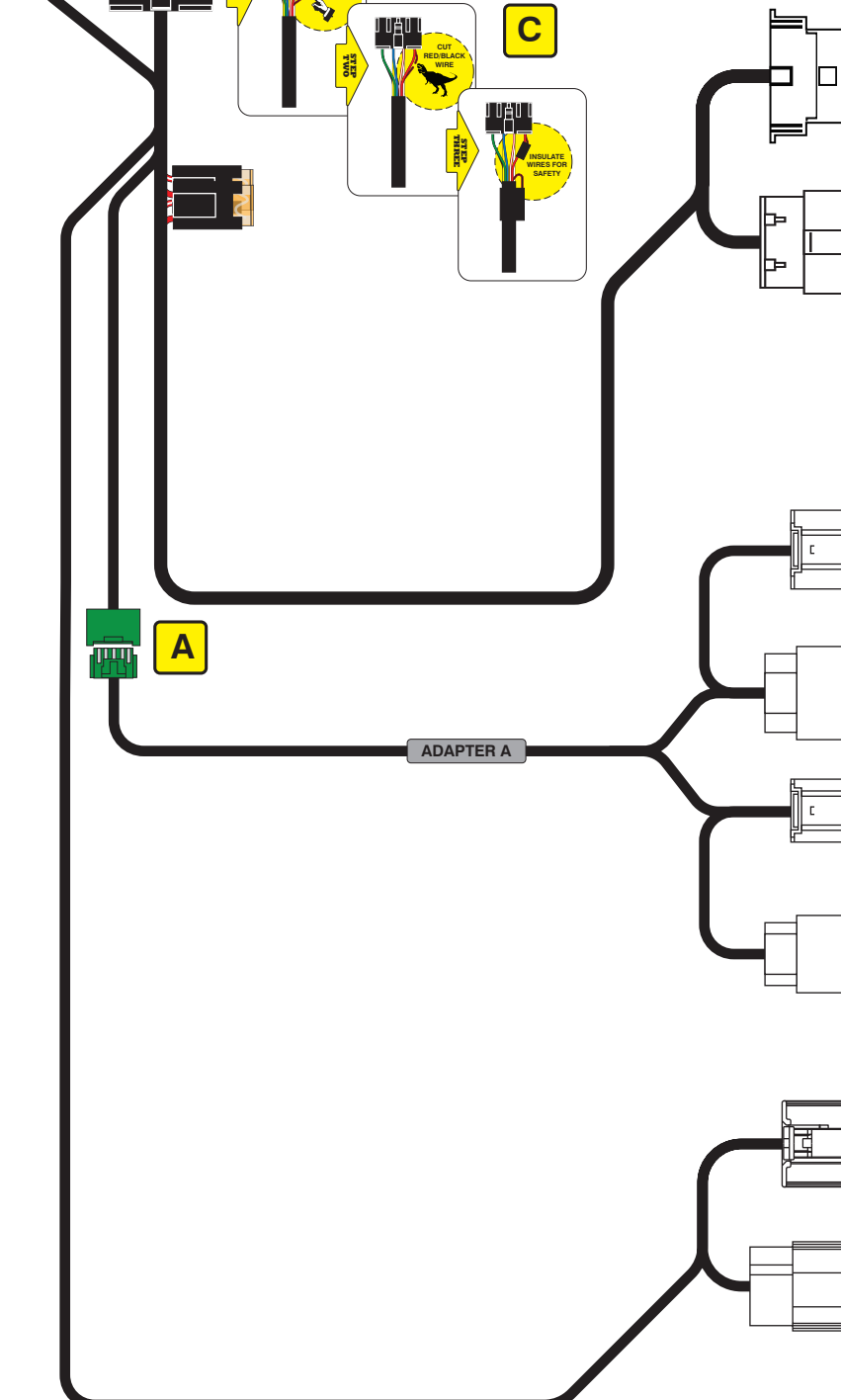

OBD-II Connector

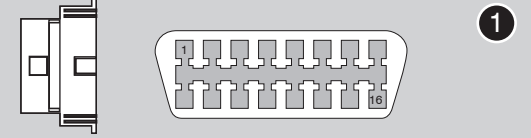

Certification ECU

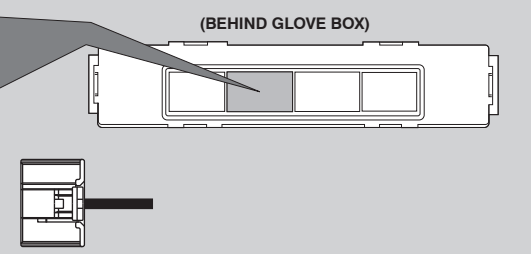
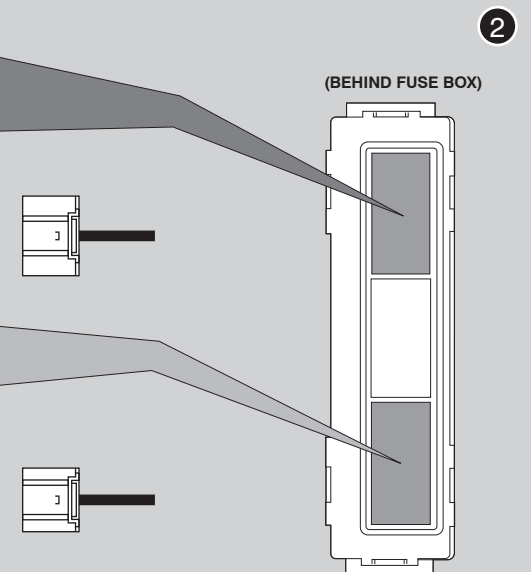

Códigos de error de programación de LED

- El LED del módulo parpadea en ROJO durante la programación
- 1x - No hay datos IMMO, arranca el coche, comprueba el cableado
 - 3x - arrancador remoto OEM detectado (eliminar)
 - 4x - No hay encendido, arranca el coche, comprueba el cableado
 - 6x - Problema de IMMO, arranca el coche, comprueba la CAN
 - 7x - Problema de IMMO, arranca el coche, comprueba la CAN

CARTRIDGE INSTALLATION

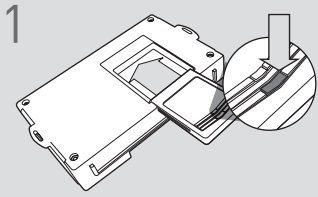

1 Slide cartridge into unit. Notice button under LED.

2

Ready for Module Programming Procedure.

MODULE PROGRAMMING PROCEDURE

NOTE

- 1 When programming, only one keyfob will be used. The other one must be located at least 10 feet away from the vehicle.

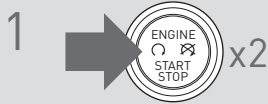

1 Push start button twice [2x] to ON position.

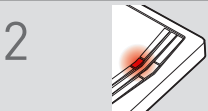

2 LED will turn solid RED.



3 Start engine.



4 Wait, LED will flash BLUE rapidly.

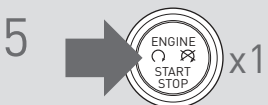

5 Push start button once [1x] to OFF position.

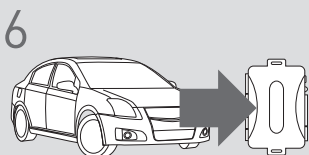

6 **WARNING:**
Disconnect power last.
Disconnect RS from vehicle.



7 Connect RS to computer and proceed with extended programming.



8 **WARNING:**
Connect power first.
Connect RS to vehicle.



9 Push start button twice [2x] to ON position.

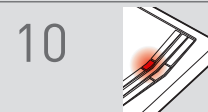

10 LED will turn solid RED.



11 Start engine.



12 Wait, LED will turn solid BLUE.



13 Push start button once [1x] to OFF position.

14

Module Programming Procedure completed.

WARNING: READ BEFORE REMOTE STARTING THE VEHICLE

IMPORTANT

- I All vehicle doors must be closed and locked prior to remote start sequence. Failure to comply will result in remote starter malfunction.

TAKE OVER PROCEDURE - TO THE VEHICLE OWNER

NOTE

- I All vehicle doors must be closed and locked prior to remote start sequence.



TIME RESTRICTION COMING UP !

1



Press UNLOCK on after-market remote.

2



TIME RESTRICTION

Within 45 SECONDS from previous step:

Have a valid key on you.
Open vehicle door.
Enter vehicle.
Close vehicle door.

Wait approximately 3 seconds for the automated takeover, then press and release BRAKE pedal.

3

Take over procedure completed.



Failure to follow this procedure will result in a vehicle engine shutdown.