

Make	Model	Year	Install	CAN	Lights	PCU	Clutch	I/O Changes
DL-HA6					Park / Auto			Green White/Blue
Honda	Accord PTS MT	2013-17	Type 1	PCU	Type B	LSC	Brown	N/A

Firmware:

This installation requires **BLADE-AL(DL)-HA6** firmware, flash module and update the controller firmware before installing.

Lights:

Type B parking light control interfaces with separate auto-light and park-light circuits at the headlight switch connector, the included adapter provides these connections without having to cut any vehicle wiring, please ensure proper configuration.

The headlight switch cable included in the latest versions of the kit provides connections for parking light and auto-light control. Use only the **BLACK Type B connector**. **Caution: Using the WHITE Type A connector will damage the light switch.**

When using the included adapter, the **parking lights (-)** and **GWR** connections in the CM I/O connector must be removed and replaced with wires from the included headlight switch adapter, as illustrated.

PCU Connections:

The 28-pin connector at the Smart PCU can be either **LIGHT BROWN** or **GRAY**, and Smart PCU locations vary by model, please consult the component locator on the following page for the proper location.

Manual Transmission Clutch Bypass: Vehicles equipped with a manual transmission require additional wiring in order to provide the required clutch signal. The **red/black** negative starter output of the **CM7/X series controller** must be connected to the vehicle clutch status wire (**brown**, in the 2-pin connector at the clutch switch (top of clutch pedal assembly)).

FTI-HDP6: Installation and Configuration Notes

- A** REQUIRED CONNECTIONS (CONNECTOR MODIFICATION REQUIRED)
- B** REQUIRED CONFIGURATION
- C** CONNECTOR COLORS VARY
- D** REQUIRED CONNECTION
- E** REQUIRED CONNECTION



FEATURE COVERAGE														
IMMOBILIZER DATA														
A/M CONTROL														
DOOR LOCK														
DOOR UNLOCK														
ARM OEM ALARM														
DISARM OEM ALARM														
TRUNK/HATCH RELEASE														
DOOR STATUS														
TRUNK STATUS														
HOOD STATUS														
BRAKE STATUS														
E-BRAKE STATUS														
TACH OUTPUT														
AUTOLIGHT CTRL														
PARKING LIGHTS														

•FT-DAS Required for manual transmission.
•BOTH Red & Red/White MUST be connected with high current application.

Jumper Setting

Parking Light	Accessory	Ignition (Default)	(+)Door Trigger In	(-)Door Trigger In (Default)
Trunk	Starter	Parking Light (Default)	Starter	Ignition
				Accessory (Default)

CM7000/7200 Cut loop for A/T

CM-900S/900AS

CM900AS/900S Jumper

START	ACC	IGN1
-------	-----	------

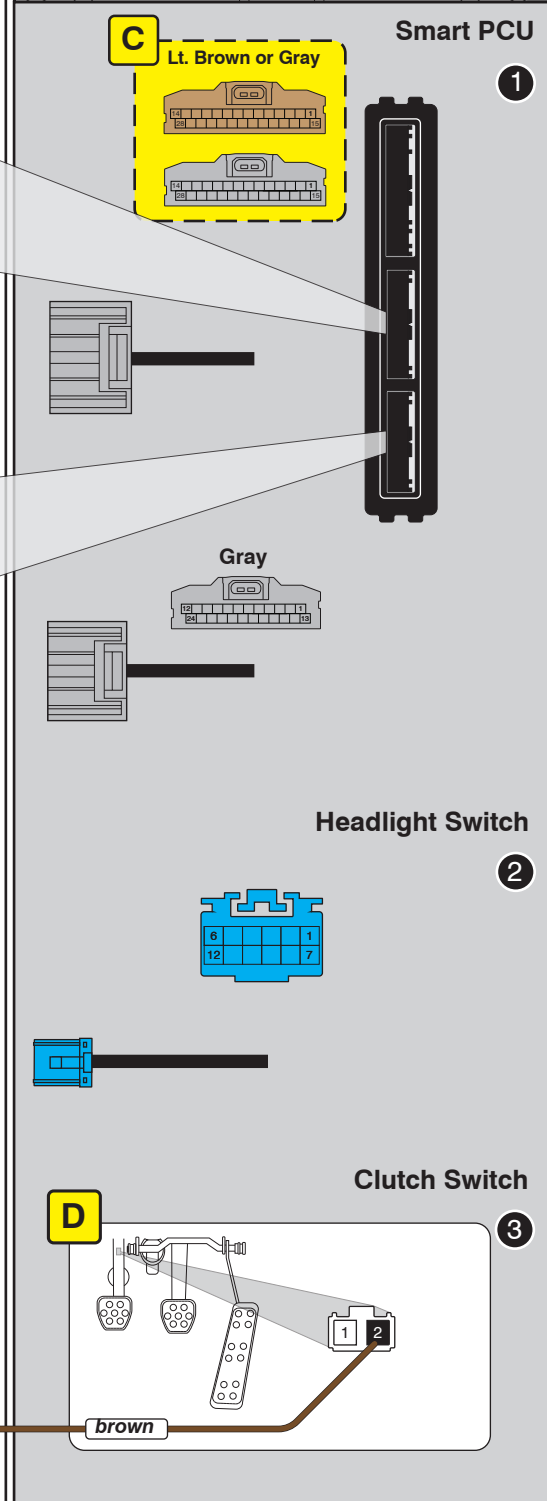
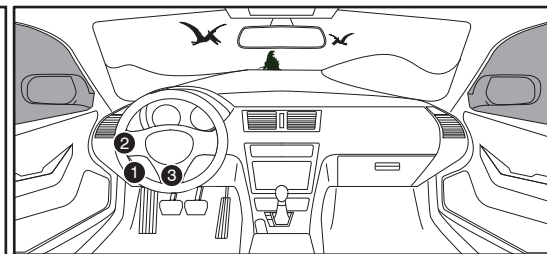
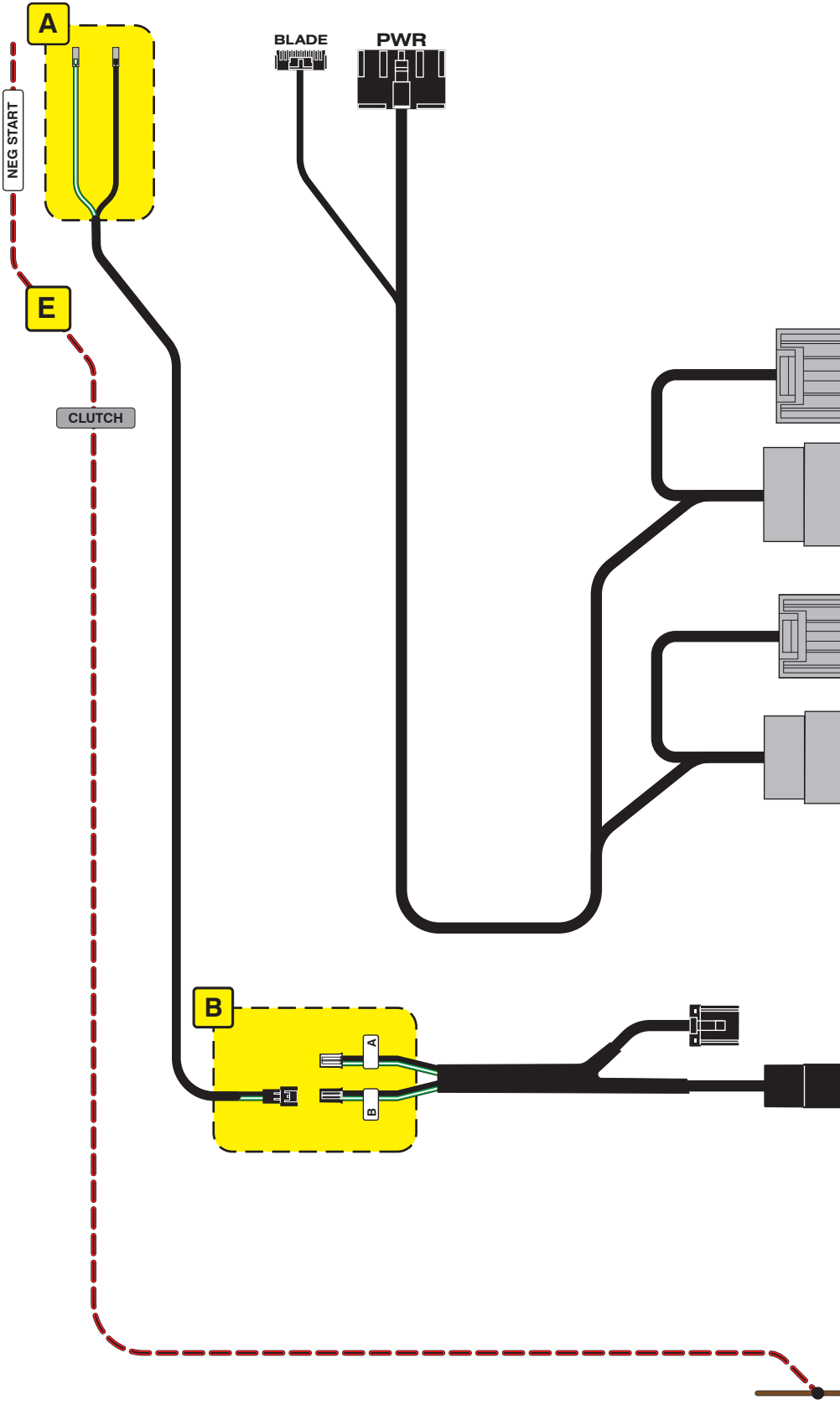

Takeover not supported: Vehicle engine will shut down when doors are opened.

LED Programming Error Codes

- Module LED flashing RED during programming
- 1x - CAN error, check connectors
- 2x - Klon error, check connections, retry programming if error persists, perform a clearing flash then retry programming with all doors closed
- 3x - Immobilizer error, check connectors, confirm car starts
- 4x - VIN error, check connectors, re flash using vehicle entry

CARTRIDGE INSTALLATION

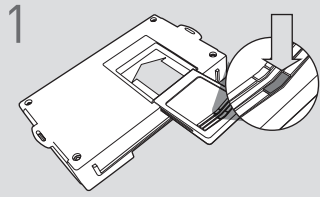

1 Slide cartridge into unit. Notice button under LED.

2

Ready for Module Programming Procedure.

MODULE PROGRAMMING PROCEDURE

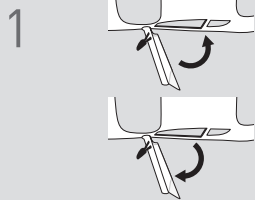

1 Close driver door.

Re-open driver door to wake up data bus.

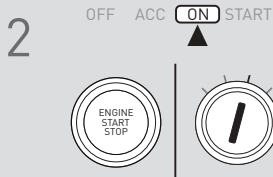

2 Turn ignition to ON position.



3 Wait, LED will flash BLUE rapidly.

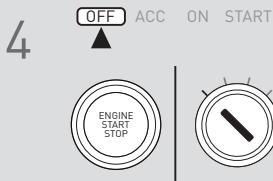

4 Turn ignition to OFF position.

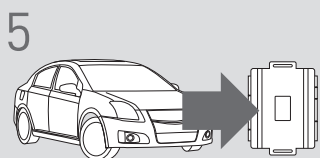

5 **WARNING:**
Disconnect power last.
Disconnect RS from vehicle.

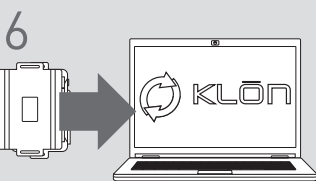

6 Connect RS to computer and proceed with extended programming.

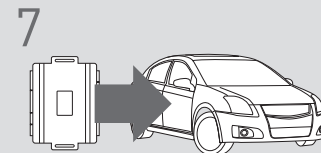

7 **WARNING:** Do not press RS programming button.
Connect power first.
Connect RS to vehicle.

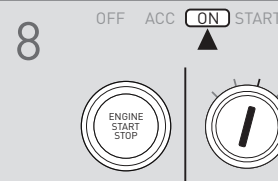

8 Turn ignition to ON position.

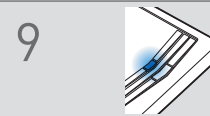

9 Wait, LED will turn solid BLUE for 2 seconds.

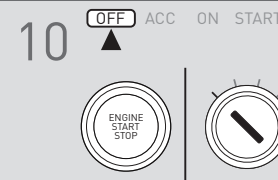

10 Turn ignition to OFF position.



11 Press UNLOCK on the OEM remote.

! If the vehicle is equipped with a power liftgate: Open and close the power liftgate with the OEM keyfob.

12

Module Programming Procedure completed.